



west virginia department of environmental protection

Office of Oil and Gas
601 57th Street, S.E.
Charleston, WV 25304
(304) 926-0450
fax: (304) 926-0452

Austin Caperton, Cabinet Secretary
www.dep.wv.gov

Wednesday, February 6, 2019
PERMIT MODIFICATION APPROVAL
Horizontal 6A / New Drill

EQT PRODUCTION COMPANY
625 LIBERTY AVE., SUITE 1700

PITTSBURGH, PA 15222

Re: Permit Modification Approval for BIG 245 H8
47-103-03234-00-00

Lateral Length

EQT PRODUCTION COMPANY

The Office of Oil and Gas has reviewed the attached permit modification for the above referenced permit. The attached modification has been approved and well work may begin. Please be reminded that the oil and gas inspector is to be notified twenty-four (24) hours before permitted well work is commenced.

If there are any questions, please feel free to contact me at (304) 926- 0450.

James A. Martin
Chief

Operator's Well Number: BIG245H8
Farm Name: ET BLUE GRASS, LLC
U.S. WELL NUMBER: 47-103-03234-00-00
Horizontal 6A New Drill
Date Modification Issued: February 6, 2019

A handwritten signature in blue ink, appearing to read "James A. Martin", is written over the signature block.

STATE OF WEST VIRGINIA
DEPARTMENT OF ENVIRONMENTAL PROTECTION, OFFICE OF OIL AND GAS
WELL WORK PERMIT APPLICATION

1) Well Operator: EQT Production Company 306686 Wetzel Grant Big Run
Operator ID County District Quadrangle

2) Operator's Well Number: BIG245H8 Well Pad Name: BIG245

3) Farm Name/Surface Owner: E.T. Bluegrass Public Road Access: Rt. 19/2

4) Elevation, current ground: 1480 Elevation, proposed post-construction: 1430

5) Well Type (a) Gas Oil Underground Storage
Other

(b) If Gas Shallow Deep
Horizontal

DMH
1270-18

6) Existing Pad: Yes or No No

7) Proposed Target Formation(s), Depth(s), Anticipated Thickness and Expected Pressure(s):
Marcellus, 7531, 51, 2620 PSI

8) Proposed Total Vertical Depth: 7531

9) Formation at Total Vertical Depth: Marcellus

10) Proposed Total Measured Depth: 14569

11) Proposed Horizontal Leg Length: 6577

12) Approximate Fresh Water Strata Depths: 229, 507, 662, 752, 1011

13) Method to Determine Fresh Water Depths: From offset wells

14) Approximate Saltwater Depths: None

15) Approximate Coal Seam Depths: 925, 1024, 1132

16) Approximate Depth to Possible Void (coal mine, karst, other): None

17) Does Proposed well location contain coal seams directly overlying or adjacent to an active mine? Yes No

(a) If Yes, provide Mine Info: Name: _____
Depth: _____
Seam: _____
Owner: _____

RECEIVED
Office of Oil and Gas
DEC 13 2018
WV Department of
Environmental Protection

18)

CASING AND TUBING PROGRAM

TYPE	<u>Size (in)</u>	<u>New or Used</u>	<u>Grade</u>	<u>Weight per ft. (lb/ft)</u>	<u>FOOTAGE: For Drilling (ft)</u>	<u>INTERVALS: Left in Well (ft)</u>	<u>CEMENT: Fill-up (Cu. Ft.)/CTS</u>
Conductor	26	New	A-500	85.6	40	40	60ft ³ / CTS
Fresh Water	13 3/8	New	J-55	54.5	1179	1179	734ft ³ / CTS
Coal							
Intermediate	9 5/8	New	P-110	40	2855	2855	2085 ft ³ / CTS
Production	5 1/2	New	P-110	20	14569	14569	500' above top producing zone
Tubing	2 3/8		J-55	4.7		May not be run, if run set 40' above top perf or 80° inclination.	
Liners							

*DMH
12/01/18*

TYPE	<u>Size (in)</u>	<u>Wellbore Diameter (in)</u>	<u>Wall Thickness (in)</u>	<u>Burst Pressure (psi)</u>	<u>Anticipated Max. Internal Pressure (psi)</u>	<u>Cement Type</u>	<u>Cement Yield (cu. ft./k)</u>
Conductor	26	30	.312	1378	18	Class A	1.18
Fresh Water	13 3/8	17 1/2	.38	2700	2160	See Variance	1.19
Coal							
Intermediate	9 5/8	12 3/8	.395	3950	3160	Class H	1.07
Production	5 1/2	8 1/2	.361	12640	10112	Class A/H	1.123/2.098
Tubing	2 3/8	NA	.19	7700			
Liners							

PACKERS

Kind:				
Sizes:				
Depths Set:				

RECEIVED
Office of Oil and Gas

DEC 13 2018

WV Department of
Environmental Protection

19) Describe proposed well work, including the drilling and plugging back of any pilot hole:

Drill and complete a new horizontal well in the Marcellus Formation. Drill the vertical to an approximate depth of 6041'. Kick off and drill curve. Drill the lateral in the Marcellus. Cement casing.

*DMH
12/10-18*

20) Describe fracturing/stimulating methods in detail, including anticipated max pressure and max rate:

Hydraulic fracturing is completed in accordance with state regulations using water recycled from previously fractured wells and obtained from freshwater sources. This water is mixed with sand and a small percentage (less than 0.1%) of chemicals (including 15% Hydrochloric acid, friction reducer, biocide, and scale inhibitor), referred to in the industry as a "slickwater" completion. Maximum anticipated internal casing pressure is expected to be approximately 10000 psi, maximum anticipated treating rates are expected to average approximately 100 bpm. Stage lengths vary from 150 to 300 feet. Average approximately 350,000 gallons of water per stage. Sand sizes vary from 100 mesh to 20/40 mesh. Average approximately 400,000 pounds of proppant per stage.

21) Total Area to be disturbed, including roads, stockpile area, pits, etc., (acres): no additional

22) Area to be disturbed for well pad only, less access road (acres): no additional

23) Describe centralizer placement for each casing string:

- Surface: Bow spring centralizers – One at the shoe and one spaced every 500'.
- Intermediate: Bow spring centralizers– One cent at the shoe and one spaced every 500'.
- Production: One solid body cent spaced every joint from production casing shoe to KOP

24) Describe all cement additives associated with each cement type:

Conductor: Class A no additives
Surface (Type 1 Cement): 0-3% Calcium Chloride. Used to speed the setting of cement slurries. .25% Flake Loss Circulation Material (LCM)
Intermediate (Class H Cement): 0-3% Calcium Chloride. Used to speed the setting of cement slurries. 0.25% flake. Loss Circulation Material (LCM) .6% Super FL-300 (fluid loss/lengthens thickening time)
Production:
Lead (Class A Cement): 0.2% CD-20 (dispersant makes cement easier to mix). .15% SuperFL-300 (fluid loss/lengthens thickening time) .15% SEC-10 (fluid loss) 50:50 POZ (extender)
Tail (Class H Cement): 0.2% Super CR-1 (Retarder). Lengthens thickening time. .3% Super FL-200 (fluid loss) .2% SEC-10 (Fluid loss). .2% SuperFL-350 (fluid loss) Reduces amount of water lost to formation. 60 % Calcium Carbonate. Acid solubility.

25) Proposed borehole conditioning procedures:

Surface: Circulate hole clean while rotating & reciprocating the drill string until cuttings diminish at surface.
Intermediate: Circulate hole clean while rotating & reciprocating the drill string until cuttings diminish at surface.
Production: Pump marker sweep with nut plug to determine actual hole washout. Calculate a gauge holes bottoms up volume. Perform a cleanup cycle by pumping 3-5 bottoms up or until the shakers are clean. Check volume of cuttings coming across the shakers every 15 minutes.

*Note: Attach additional sheets as needed.

47-103-03234

RECEIVED
Office of Oil and Gas

DEC 13 2018

WV Department of
Environmental Protection

Well **BIG245H8**
EQT Production
Big Run Quad
Wetzel County, WV

ENERTIA # 514369
Azimuth 337
Vertical Section 6724

Note: Diagram is not to scale

Formations	Top TVD	Base TVD
Conductor	40	
Base Red Rock	967	
Base Fresh Water	1011	
Surface Casing	1179	
Maxton	2305 - 2346	
Big Lime	2359 - 2429	
Big Injun	2429 - 2596	
Intermediate Casing	2855	
Gordon	3163 - 3202	
Forth Sand	3221 - 3265	
Bayard	3269 - 3499	
Speechley	3891 - 4113	
Riley	4684 - 4916	
Benson	5380 - 5528	
Alexander	5842 - 6158	
Sonyea	7063 - 7140	
Middlesex	7140 - 7324	
Genesee	7324 - 7362	
Geneseo	7362 - 7388	
Tully	7388 - 7410	
Hamilton	7410 - 7509	
Marcellus	7509 - 7560	
Production Casing	14569	MD
Onondaga	7560	

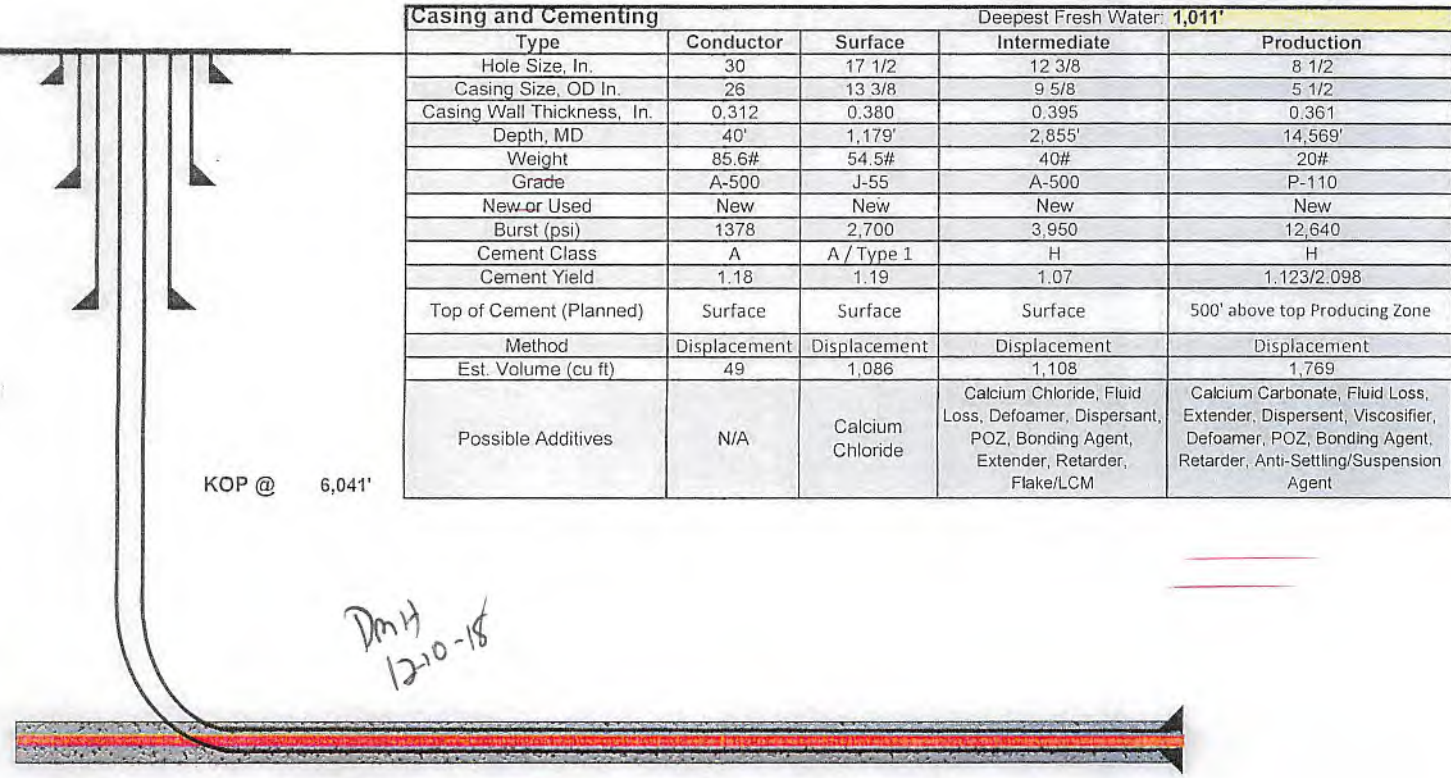

Casing and Cementing		Deepest Fresh Water: 1,011'		
Type	Conductor	Surface	Intermediate	Production
Hole Size, In.	30	17 1/2	12 3/8	8 1/2
Casing Size, OD In.	26	13 3/8	9 5/8	5 1/2
Casing Wall Thickness, In.	0.312	0.380	0.395	0.361
Depth, MD	40'	1,179'	2,855'	14,569'
Weight	85.6#	54.5#	40#	20#
Grade	A-500	J-55	A-500	P-110
New or Used	New	New	New	New
Burst (psi)	1378	2,700	3,950	12,640
Cement Class	A	A / Type 1	H	H
Cement Yield	1.18	1.19	1.07	1.123/2.098
Top of Cement (Planned)	Surface	Surface	Surface	500' above top Producing Zone
Method	Displacement	Displacement	Displacement	Displacement
Est. Volume (cu ft)	49	1,086	1,108	1,769
Possible Additives	N/A	Calcium Chloride	Calcium Chloride, Fluid Loss, Defoamer, Dispersant, POZ, Bonding Agent, Extender, Retarder, Flake/LCM	Calcium Carbonate, Fluid Loss, Extender, Dispersant, Viscosifier, Defoamer, POZ, Bonding Agent, Retarder, Anti-Settling/Suspension Agent

Land curve @ 7,531' TVD
7,992' MD

Est. TD @ 7,531' TVD
14,569' MD

6,577' Lateral

Proposed Well Work:
Drill and complete a new horizontal well in the Marcellus formation.
Drill the vertical to an approximate depth of 6041'.
Kick off and drill curve. Drill lateral in the Marcellus. Cement casing.

STATE OF WEST VIRGINIA
DEPARTMENT OF ENVIRONMENTAL PROTECTION
OFFICE OF OIL AND GAS

FLUIDS/ CUTTINGS DISPOSAL & RECLAMATION PLAN

Operator Name EQT Production Company OP Code 306686

Watershed (HUC 10) Rockcamp Run of Wiley Fork Quadrangle Big Run

Do you anticipate using more than 5,000 bbls of water to complete the proposed well work? Yes No

Will a pit be used? Yes No

If so, please describe anticipated pit waste: n/a

Will a synthetic liner be used in the pit? Yes No If so, what ml.? n/a

Proposed Disposal Method For Treated Pit Wastes:

- Land Application
- Underground Injection (UIC Permit Number 0014, 8462, 4037)
- Reuse (at API Number Various)
- Off Site Disposal (Supply form WW-9 for disposal location)
- Other (Explain _____)

*DMH
12-10-18*

Will closed loop system be used? If so, describe: Yes, The closed loop system will remove drill cuttings from the drilling fluid. The drill cuttings are then prepared for transportation to an off-site disposal facility.

Drilling medium anticipated for this well (vertical and horizontal)? Air, freshwater, oil based, etc. See Attached

-If oil based, what type? Synthetic, petroleum, etc. Synthetic Mud

Additives to be used in drilling medium? See Attached

Drill cuttings disposal method? Leave in pit, landfill, removed offsite, etc. Landfill

-If left in pit and plan to solidify what medium will be used? (cement, lime, sawdust) N/A

-Landfill or offsite name/permit number? See Attached List

Permittee shall provide written notice to the Office of Oil and Gas of any load of drill cuttings or associated waste rejected at any West Virginia solid waste facility. The notice shall be provided within 24 hours of rejection and the permittee shall also disclose where it was properly disposed.

I certify that I understand and agree to the terms and conditions of the GENERAL WATER POLLUTION PERMIT issued on August 1, 2005, by the Office of Oil and Gas of the West Virginia Department of Environmental Protection. I understand that the provisions of the permit are enforceable by law. Violations of any term or condition of the general permit and/or other applicable law or regulation can lead to enforcement action.

I certify under penalty of law that I have personally examined and am familiar with the information submitted on this application form and all attachments thereto and that, based on my inquiry of those individuals immediately responsible for obtaining the information, I believe that the information is true, accurate, and complete. I am aware that there are significant penalties for submitting false information, including the possibility of fine or imprisonment.

Company Official Signature *Erin Spine*

Company Official (Typed Name) Erin Spine

Company Official Title Regional Land Supervisor

RECEIVED
Office of Oil and Gas

DEC 13 2018

WV Department of
Environmental Protection

Subscribed and sworn before me this 29 day of November, 2018

Rebecca L. Wanstreet

Notary Public

My commission expires 4-7-2020



WW-9 Attachment

Drilling medium anticipated for this well (vertical and horizontal)? Air, freshwater, oil based, etc.

- Air is used to drill the top-hole sections of the wellbore (surface, intermediate, and pilot). Water based mud may be necessary depending on hole conditions to stabilize and drill the intermediate section. The pilot hole, curve, and lateral sections will be drilled with either air, water based mud, or oil based mud.

Additives to be used in drilling medium?

- Air - biodegradable oil lubricant, detergent, defoaming, water. Water based mud – Barite, viscosifer, alkalinity control, lime, filtration control, deflocculates, biodegradable oil lubricant, defoaming, walnut shell, salt, x-cide, carbonates. Oil based mud – synthetic base oil, emulsifier, salt, lime, viscosifer, alkalinity control, filtration control, deflocculates, biodegradable oil lubricant, defoaming, carbonates.

RECEIVED
Office of Oil and Gas

DEC 13 2018

WV Department of
Environmental Protection

EQT Production Company

Proposed Revegetation Treatment: Acres Disturbed no additional Prevegetation pH _____

Lime 3 Tons/acre or to correct to pH 6.5

Fertilizer type Granular 10-20-20

Fertilizer amount 1/3 lbs/acre

Mulch 2 Tons/acre

Seed Mixtures

Temporary		Permanent	
Seed Type	lbs/acre	Seed Type	lbs/acre
KY-31	40	Orchard Grass	15
Alsike Clover	5	Alsike Clover	5
Annual Rye	15		

Attach:

Maps(s) of road, location, pit and proposed area for land application (unless engineered plans including this info have been provided). If water from the pit will be land applied, include dimensions (L x W x D) of the pit, and dimensions (L x W), and area in acreage, of the land application area.

Photocopied section of involved 7.5' topographic sheet.

Plan Approved by: [Signature]

Comments: _____

Title: Oil + Gas Inspector Date: 12/10/18

Field Reviewed? Yes No

RECEIVED
Office of Oil and Gas

DEC 13 2018

WV Department of
Environmental Protection



Where energy meets innovation.™

Site Specific Safety and Environmental Plan

EQT

BIG245 Pad

Burton

Wetzel County, WV

BIG245H4, BIG245H5, BIG245H6, For Wells: BIG245H8, BIG245H16, BIG245H17

Date Prepared: February 23, 2018

[Signature]
EQT Production

Regional Land Supervisor
Title

11/29/2018
Date

[Signature]
WV Oil and Gas Inspector

Oil + Gas Inspector
Title

12-7-18
Date

RECEIVED
Office of Oil and Gas
DEC 13 2018
WV Department of
Environmental Protection

THIS PAGE INTENTIONALLY LEFT BLANK

RECEIVED
Office of Oil and Gas
DEC 13 2018
WV Department of
Environmental Protection

TABLE OF CONTENTS

Section	Description	Page
	Document Title Page.....	1
	Table of Contents	3
	Record of Revision and Change	5
I	Contacts, Schedules, & Meetings	7
II	Maps & Diagrams	14
III	Well Work: Marcellus & Utica Regions.....	20
IV	Chemical Inventory & SDS	26
V	BOP&WellControlforMarcellusand Utica Regions	28
VI	Hydrogen Sulfide	34
VII	Flaring	37
XIII	Collision Avoidance	38
IX	Deep Well Additional Requirements	41
X	Well Site Safety Plan Receipt Acknowledgement	42

Attachments

Response Guides
 EQT Preparedness, Prevention and Contingency Plan
 EQT Control and Disposal Plan
 EQT Containment Plan
 EQT Training Log
 EQT Tailgate Safety Meeting Form
 EQT Phone Threat Response Form
 Hydrogen Sulfide (H₂S) Plan
 LNG/CNG Trailer Unload Operations
 Access Control Form

RECEIVED
 Office of Oil and Gas
 DEC 13 2018
 WV Department of
 Environmental Protection

This Page Left Intentionally Blank

RECEIVED
Office of Oil and Gas
DEC 13 2018
WV Department of
Environmental Protection

Site Specific Emergency Action Plan		
<u>Rev #</u>	<u>Rev Date</u>	<u>Rev Changes</u>
000	2/23/18	Original
Plan Administrator: Scott M. Held Senior Safety Coordinator	Approval: Scott M. Held Senior Safety Coordinator	RECEIVED Office of Oil and Gas DEC 13 2018 WV Department of Environmental Protection
Assistant Plan Administrator: Michael Mollick Contractor – Emergency Action Planning	Final Approver: Brian O’Neil Supervisor, Drilling and Completions Safety	

This Page Left Intentionally Blank

RECEIVED
Office of Oil and Gas
DEC 13 2018
WV Department of
Environmental Protection

Section I: Contacts, Schedules and Meetings

EMERGENCY SERVICES	
<u>County Emergency Dispatch Center</u>	PHONE NUMBER
Wetzel County 911	EMERGENCY 9-1-1
- For Police, Fire, Ambulance	10-digit: 304-455-6730
<u>County Emergency Services/ Management (CES)</u>	
Wetzel County Office of Emergency Management P.O. Box156 New Martinsville, WV 26155 Director: Edgar Sapp	10-digit: 304-455-6730 Office: 304-455-6960
<u>Nearest Hospital</u>	ER Phone Number
Wetzel County Hospital 3 E. Benjamin Dr New Martinsville, WV26155 Distance: 28.6 miles Travel Time: 58 mins	10-digit: 304-455-8100
SEE ATTACHED MAP	

EQT EMERGENCY CONTACTS	
EQT 24-Hour	1-800-926-1759
EQT Environmental - Dustin Howarth	O: 724-746-9008 C: 412-208-5758
EQT Health and Safety Department - Brian O'Neil	O: 724-743-4688 C: 412-463-6430
EQT Government and Community Relations Local Government - Nathaniel Manchin, Manager Community Relations	O: 412-553-5702 C: 304-543-5010
EQT State Government, WV Government Relations Manager - Gregory Hoyer	304-348-3886 304-546-1923

RECEIVED
Office of Oil and Gas
DEC 13 2018
WV Department of
Environmental Protection



39.593922, -80.569740 to Wetzel County Hospital

Drive 28.6 miles, 58 min

WV Wetzel BIG 245 Unit Pad Hospital Directions

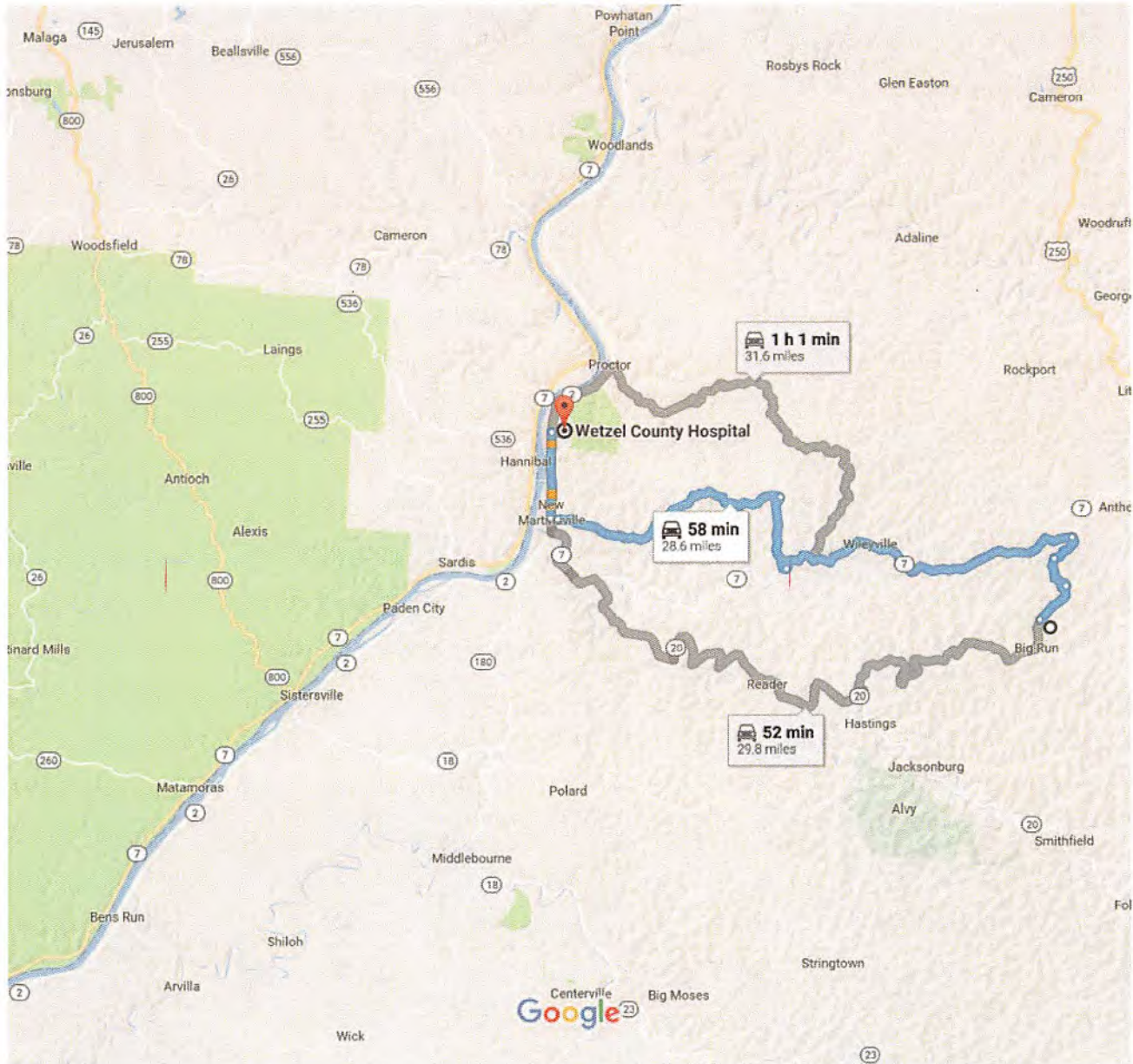

Map data ©2016 Google

RECEIVED
Office of Oil and Gas

DEC 13 2018

WV Department of
Environmental Protection
12 min (4.0 mi)

39.593922, -80.569740

Follow Big Run, Co Rd 58/1 and Four Mile Rd to WV-7 W in 2

- ↑ 1. Head northeast on Big Run

1.4 mi

02/08/2019

- ↑ 2. Continue onto Co Rd 58/1 1.5 mi
- ↘ 3. Turn right onto Four Mile Rd 1.0 mi
- ↙ 4. Turn left onto Kodol Rd 52 ft
- ↙ 5. Slight left onto WV-7 W 15 min (10.5 mi)

Take New Martinsville Newdale to WV-2 N/3rd St in New Martinsville

- ↘ 6. Turn right onto Carpenter Ridge 23 min (11.1 mi)
- ↙ 7. Turn left onto Doolin Run Rd/New Martinsville Newdale 2.6 mi
i Continue to follow New Martinsville Newdale 8.2 mi
- ↑ 8. Continue onto Doolin Run Rd/North St 0.2 mi
i Continue to follow North St
- ↘ 9. Turn right onto WV-2 N/3rd St 6 min (2.7 mi)
i Continue to follow WV-2 N
- ↘ 10. Turn right onto E Benjamin Dr 1 min (0.4 mi)

Wetzel County Hospital

3 East Benjamin Drive, New Martinsville, WV 26155

These directions are for planning purposes only. You may find that construction projects, traffic, weather, or other events may cause conditions to differ from the map results, and you should plan your route accordingly. You must obey all signs or notices regarding your route.

RECEIVED
Office of Oil and Gas
DEC 13 2018
WV Department of
Environmental Protection

OTHER EMERGENCY CONTACTS	
WVDEP Office of Oil & Gas – Pollution & Emergency Spills	1-800-642-3074
Local State Well Inspector: Derek Haught	304-206-7613
USCG/National Response Center (NRC)	800-424-8802
CHEMTREC	Emergency 800-424-9300 Business: 800-262-8200
US DOT Pipeline & Hazardous Materials Safety Administration (PHMSA)	Pipeline: 202-366-4595 HazMat: 800-467-4922

Notification Methods

Notification of the public will be made in conjunction with EQT personnel listed above and emergency first responders listed above in the event that they are affected by an event such as hydrogen sulfide releases, blow-outs and flaring. The public list is attached to the map listed in Section II: Maps and Diagrams and the procedures for notification, isolation zones, and evacuations are also listed in Section II: Maps and Diagrams.

Flaring notification procedures are listed in Section V: BOP and Well Control.

Additional actions and precautions for the presence of hydrogen sulfide are listed in Section VI: Hydrogen Sulfide.

Pre-Drill Meeting

A Pre-Drill Meeting will be held on location with the following personnel in attendance:

- WV OOG Inspector and /or Supervisor
- EQT Land Agent
- EQT Construction Specialist
- EQT Drilling Contractor Personnel, i.e. Tool Pusher, Driller(s), Safety Manager
- EQT On-Site Drilling Specialist and/or Supervisor

Optional attendees may include:

- EQT Safety and Health Coordinator or designee, if available
- EQT Environmental Coordinator or designee, if available
- EQT H2S Contractor representative, if in an H2S plan required zone.
- EQT Completions Personnel

RECEIVED
Office of Oil and Gas
DEC 13 2018
WV Department of
Environmental Protection

Safety Meetings

A completed and documented EQT Tailgate Safety Meeting (TSM) or Contractor Representative Tailgate Talk or Job Safety Analysis (JSA) is required prior to the beginning of each work shift during all phases of the operation. Copies of these forms should be logged and kept in a location on-site for periodic auditing by EQT or the contractor.

See the attached EQT Tailgate Safety Meeting (TSM) Form on the following pages.

EQT Tailgate Safety Meeting

Section 1: General Information				
Date & Time: _____	Location/Physical Address: _____			
Project Name: _____	GPS Coordinates: _____			
Emergency Contact: _____	Emergency Notification #: _____			
DIAL 911 FOR ALL EMERGENCIES – IF 911 IS NOT AVAILABLE, LIST AN ALTERNATIVE NUMBER: _____				
Primary Assembly Point: _____	Secondary Assembly Point: _____			
Nearest Medical Facility: _____	Nearest Fire Extinguisher: _____			
Nearest First Aid Kit: _____	Nearest Eye Wash: _____			
Do Cell Phones Work: <input type="checkbox"/> Yes <input type="checkbox"/> No	Project Name: _____			
Are other personnel on-site conducting tasks not related to this task? <input type="checkbox"/> Yes <input type="checkbox"/> No				
If you answered YES to the question above, will the other personnel be affected by this task? <input type="checkbox"/> YES <input type="checkbox"/> NO				
If you answered YES to the question above, have you included those personnel in this TSM? <input type="checkbox"/> YES <input type="checkbox"/> NO				
Section 2: Task Information				
Describe the task to be performed: _____ _____				
Are the employees working on a task out of sight of each other? If so, what communication method is being used? <input type="checkbox"/> Cell Phone <input type="checkbox"/> Land Line <input type="checkbox"/> 2-Way Radio <input type="checkbox"/> Other				
Section 3: Hazard Identification & Control				
Type of Work: <input type="checkbox"/> Hot Work <input type="checkbox"/> Lockout/Tagout <input type="checkbox"/> Excavation <input type="checkbox"/> Confined Space (If checked, additional permits/forms must be completed)				
Mark An X On All Applicable Hazards For This Task:				
<input type="checkbox"/> Hazardous Atmosphere <input type="checkbox"/> Temperature Extremes (Heat & Cold) <input type="checkbox"/> Safety Systems Bypassed/Disabled <input type="checkbox"/> Trapped Pressure <input type="checkbox"/> Fall From Heights <input type="checkbox"/> Moving Machinery <input type="checkbox"/> Suspended Loads/Rigging <input type="checkbox"/> Ignition Sources	<input type="checkbox"/> Overhead Hazards <input type="checkbox"/> Chemical Exposure <input type="checkbox"/> Weather Hazards <input type="checkbox"/> Heavy Loads <input type="checkbox"/> Noise <input type="checkbox"/> Electrical <input type="checkbox"/> Pinch Points <input type="checkbox"/> Lone Worker	<input type="checkbox"/> Hydrates/Line Blockage <input type="checkbox"/> Lifting (Sprains & Strains) <input type="checkbox"/> Condensate/Flammability <input type="checkbox"/> Slips/Trips/Falls (Alternate Route) <input type="checkbox"/> Excavation Collapse <input type="checkbox"/> Adjacent Operations <input type="checkbox"/> Mobile Equipment <input type="checkbox"/> Overexertion	<input type="checkbox"/> Radiation <input type="checkbox"/> Asbestos/Lead Materials <input type="checkbox"/> PCBs <input type="checkbox"/> Dusty Environment <input type="checkbox"/> Roadway Work (Traffic Control) <input type="checkbox"/> Wildlife (Snakes, Bears, etc.) <input type="checkbox"/> Insects (Bees, Ticks, etc.) <input type="checkbox"/> Poison Oak, Ivy, Sumac <input type="checkbox"/> Other _____	
Describe location driving hazards (well heads, barriers, tanks, low hanging tree limbs, etc.) and parking location. _____				
Section 4: Personal Protective Equipment				
Mark An X Next To Required PPE: HARD HAT, SAFETY GLASSES AND HARD TOE BOOTS ARE ALWAYS REQUIRED				
GENERAL PPE <input type="checkbox"/> Face Shield <input type="checkbox"/> FR Clothing <input type="checkbox"/> Hearing Protection <input type="checkbox"/> Chainsaw Chaps <input type="checkbox"/> Other _____	GLOVES <input type="checkbox"/> General Purpose <input type="checkbox"/> Chemical Resistant <input type="checkbox"/> Heat Resistant <input type="checkbox"/> Other _____	Fall Arrest <input type="checkbox"/> Harness <input type="checkbox"/> Lanyard <input type="checkbox"/> Retrieval Line <input type="checkbox"/> Other _____	Personal Monitors <input type="checkbox"/> 4-Gas Monitor <input type="checkbox"/> H ₂ S <input type="checkbox"/> O ₂ <input type="checkbox"/> LEL	RESPIRATOR TYPE* <input type="checkbox"/> Dust Mask <input type="checkbox"/> ½ Mask APR <input type="checkbox"/> SCBA <input type="checkbox"/> Other _____
*Note: (Employees/Contractors must be medically qualified and trained in order to wear a respirator)				
Section 5: TSM Completion				
EQT TSM Leader: Print: _____ Signature: _____				
List EQT Employees conducting the tasks and participating in the TSM: (Attach a separate page if additional space is needed or use back of sheet)				
Print: _____	Print: _____			
Print: _____	Print: _____			
Contractor Name (if applicable): _____				
List all contract employees conducting the task: (Attach a separate page if additional space is needed or use back of sheet)				
Print: _____	Print: _____			
Print: _____	Print: _____			
Note: All personnel arriving after initial TSM shall be tailgated: (Attach a separate page if additional space is needed or use back of sheet)				
Comments: _____				

RECEIVED
Office of Oil and Gas
DEC 13 2018
WV Department of
Environmental Protection

EQT Tailgate Safety Meeting

List EQT Employees conducting the tasks and participating in the TSM:

Print: _____	Print: _____	Print: _____
Print: _____	Print: _____	Print: _____
Print: _____	Print: _____	Print: _____
Print: _____	Print: _____	Print: _____
Print: _____	Print: _____	Print: _____
Print: _____	Print: _____	Print: _____
Print: _____	Print: _____	Print: _____
Print: _____	Print: _____	Print: _____
Print: _____	Print: _____	Print: _____
Print: _____	Print: _____	Print: _____
Print: _____	Print: _____	Print: _____
Print: _____	Print: _____	Print: _____
Print: _____	Print: _____	Print: _____
Print: _____	Print: _____	Print: _____
Print: _____	Print: _____	Print: _____
Print: _____	Print: _____	Print: _____

Contractor Name (if Applicable): _____

List contract employees conducting the task and participating in TSM:

Print: _____	Print: _____	Print: _____
Print: _____	Print: _____	Print: _____
Print: _____	Print: _____	Print: _____
Print: _____	Print: _____	Print: _____
Print: _____	Print: _____	Print: _____
Print: _____	Print: _____	Print: _____
Print: _____	Print: _____	Print: _____
Print: _____	Print: _____	Print: _____
Print: _____	Print: _____	Print: _____
Print: _____	Print: _____	Print: _____
Print: _____	Print: _____	Print: _____
Print: _____	Print: _____	Print: _____
Print: _____	Print: _____	Print: _____
Print: _____	Print: _____	Print: _____
Print: _____	Print: _____	Print: _____
Print: _____	Print: _____	Print: _____

RECEIVED
Office of Oil and Gas

DEC 13 2018

WV Department of
Environmental Protection

Note: Retain document for 2 years

Section II: Maps and Diagrams

General Information Pertaining to well pad location:

WV- Wetzel County – Burton
Site State, County and Municipality

EQT BIG245 Pad
Site Location Designation

1510 Anderson Run Rd. Burton, WV 26562
Site Address assigned by County 9-1-1

Wiley Fork Road
Nearest cross road(s)

39.593922, -80.569740
Access Road Coordinates

39.595333, -80.568706
Pad Site Coordinates

Directions:

SEE ATTACHED EQT Traffic Control Plan –NOT AVAILABLE.

North on I-79 to exit 121 turn left at bottom of Ramp and go 4.8 miles on C/R 24 to Intersection of US19. Turn Right and go North +/- 1.8 miles on US 19 to junction of WV RT 20. Turn Left (North) for approximately 32.6 miles to C/R 15 (North Fork Road), Turn Right, go 8.2 miles to CR 19 (Wiley Fork Road). Continue Straight onto CR 19 and go .88 miles. Turn left up existing Company Access Road

Maps:

Maps are included on the following pages for reference for the above described well location. The two types of maps included are:

1. Plan View Map
2. Topographical map with 1-mile safety radius

Site Evacuation Plan:

Assembly areas:

- Each Site is responsible for identifying a designated assembly area for personnel to safely evacuate to in the event of an emergency.
- Evacuation in place may be most suitable for inclement weather but that decision shall be made by the On-Site Specialist or Emergency Coordinator (Examples: Near the access road, Site Location Sign, On-Site Specialist trailer).
- Assembly points should be determined so as to be upwind in consideration of the prevailing wind at the site.
- At a minimum, a secondary assembly area shall be determined. Secondary assembly points should be located to be 90 degrees to the prevailing wind.
- Each determined assembly area shall be communicated to all personnel on the site.

Affected and Unaffected areas:

- The Emergency Coordinator, or their representative, will establish the emergency area as the affected area and order the evacuation of all non-essential personnel to the primary assembly area.
- The purpose is to minimize the risk of exposure to all personnel.
- On-site rescuers and equipment should be staged in areas unaffected by the emergency.

RECEIVED
Office of Oil and Gas
DEC 13 2018
WV Department of
Environmental Protection

- Off-site services and equipment summoned to the scene should be staged in areas unaffected by the emergency.
- Only essential personnel, as determined by the Emergency Coordinator, shall be granted entry into the affected area(s) after an emergency has occurred.

Evacuation:

- In the event of an emergency all non-essential personnel shall immediately evacuate their work areas and report to the Assembly Area.
- Evacuation must be quick as life safety may be of the essence.
- Personnel should evacuate to the assembly area via the quickest route. If that route is blocked or hazardous, another route should be taken.
- Personnel should make sure that their co-workers heard the call for evacuation and assure that no one is left behind.
- Only essential personnel required for process critical jobs can stay behind, all others shall evacuate. This decision shall be at the sole discretion of the Emergency Coordinator and in no means should life safety be jeopardized.
- Should the primary assembly area be unsuitable for evacuation, the alternate location shall be communicated to all personnel. The Emergency Coordinator or their designee is responsible for determining the safest assembly area.
- Accountability shall be verified as soon as possible by the Emergency Coordinator or their designee. Those who are unaccounted for shall be immediately reported to the Emergency Coordinator
- If evacuation is required for the surrounding areas, notifications to all personnel listed on the attached Topographical and One-Mile Safety Buffer Map and contact list shall be made by the On-Site Emergency Coordinator or their designee with the assistance of the emergency first responders and the county LEPC or CES.
- Evacuation locations and assembly areas will be made with the coordination of local emergency first responders.

Scene Access:

- Access to the scene should be controlled at all times by the Emergency Coordinator or their representative.
- Access needs to be controlled to reduce life safety concerns as well as preserve evidence for investigation and root cause analysis.
- Access should never be restricted in a way as to impede those who are evacuating in an emergency.
- The scene needs to be secured to prevent unauthorized entry by posting signs, tape, personnel, or other means at any and all access points.
- Unauthorized access into the affected area(s) is prohibited and calls for immediate removal from the site.

Accountability:

- The daily TSM or JSA shall be used to verify accountability for all personnel as soon as possible after an incident has occurred.
- A sign in and out sheet shall be used to account for personnel entering and exiting the area after an incident has occurred.
- All personnel unaccounted for shall be immediately reported to the Emergency Coordinator as well as emergency first responders.

RECEIVED
Office of Oil and Gas
DEC 13 2018
WV Department of
Environmental Protection

Plan View (Aerial) Map:

See the attached West Virginia Rec Plans on the following pages for each well number listed on the permit cover page.

Plan View map notes:

This is a basic map of the site which shows the access road(s), nearby dwellings, and true north direction.

The prevailing wind direction for this area is from the southwest unless otherwise noted. Flare lines, if needed, will be run and installed as per procedure.

Topographical map with 1-mile safety radius

See the attached topographical map on the following pages along with the attached list with emergency contact information.

Topographical map with 1-mile safety radius map notes:

This is a basic map of the site which shows the topography of the area.

A defined 1-mile safety radius is shown on the map along with an attached list, if available, of the names, addresses and telephone numbers of residents, churches, schools and emergency facilities located within that one mile radius.

The map shows the nearby public route numbers and/or names

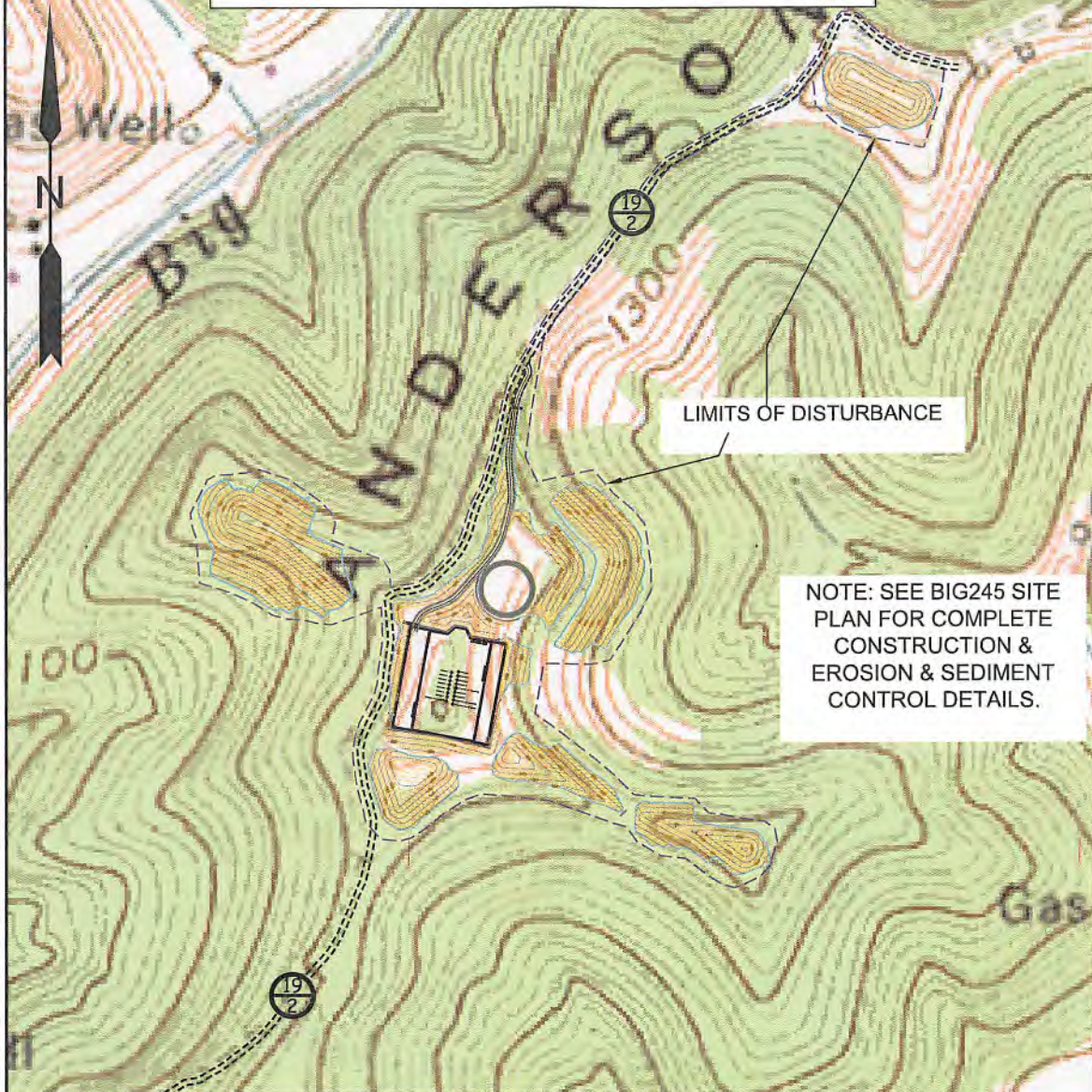

LIMITS OF DISTURBANCE

NOTE: SEE BIG245 SITE PLAN FOR COMPLETE CONSTRUCTION & EROSION & SEDIMENT CONTROL DETAILS.

Detail Sketch for Proposed BIG245 Wells

NOTE: SEE BIG245 SITE PLAN FOR COMPLETE CONSTRUCTION & EROSION & SEDIMENT CONTROL DETAILS.

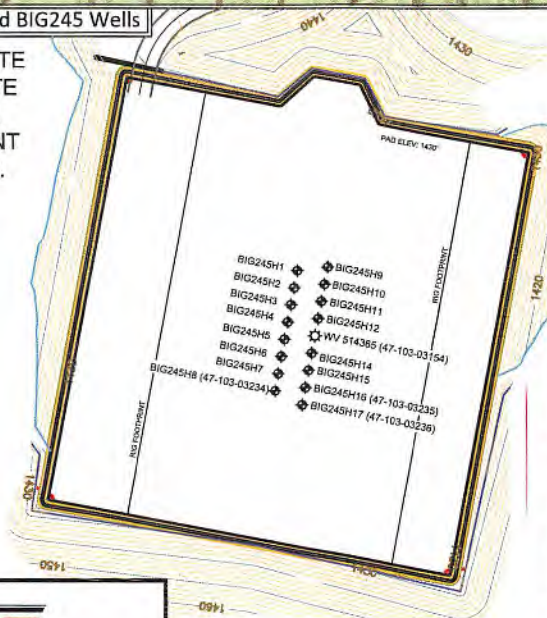

Not To Scale

SLS
Land & Energy Development
Solutions from the ground up.
P.O. Box 150 • 12 Vermont Drive • Glenville, WV 26031 • (204) 402-0634
www.slsenergy.com

DRAWN BY MGF	FILE NO. 7812	DATE 09-21-18	CADD FILE: 7812BIG245REPLAN-RL.dwg
-----------------	------------------	------------------	---------------------------------------

TOPO SECTION OF BIG RUN 7.5'
USGS TOPO QUADRANGLE

SCALE: 1"=500'



RECEIVED
Office of Oil and Gas
DEC 13 2018
WV Department of
Environmental Protection



EQT Corporation
625 Liberty Ave.
Pittsburgh, PA 15222

Legend

02/08/2019

1:4,500
Miles
0 0.035 0.07

© 2014 Esri. All rights reserved. Esri and ArcGIS are either registered trademarks or trademarks of Esri in the United States and/or other countries. Microsoft, Bing, and Windows are either registered trademarks or trademarks of Microsoft in the United States and/or other countries.



Title: WV Wetzel BIG 245 Unit

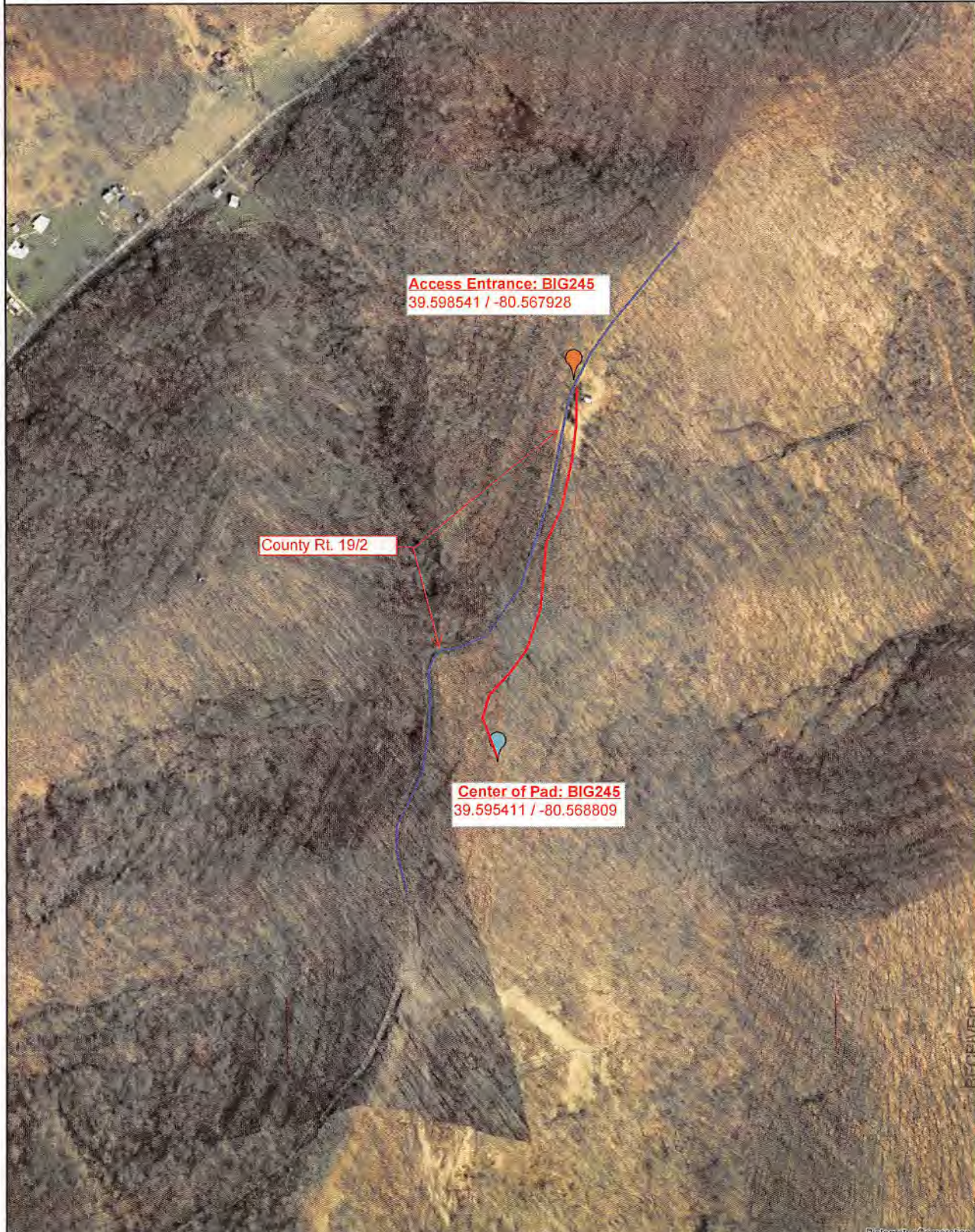

RECEIVED
Office of Oil and Gas

DEC 13 2018

WV Department of
Environmental Protection

Disclaimer: This map is confidential and is to be used only for the express informational purposes for which it was created. Unauthorized use, copying, or dissemination is strictly prohibited. EQT does not warrant the accuracy of the location of any items shown on this map, including, but not limited to, any structures, well or pipeline facilities, property boundaries, topography, roads, or waterways. The items shown on this map may not have been placed on the map using survey data or GPS coordinates. The specific location of any of the map items should be determined by a field survey performed by a licensed surveyor upon consultation with EQT. 17



Copyright © 2013 National Geographic Society, i-cubed

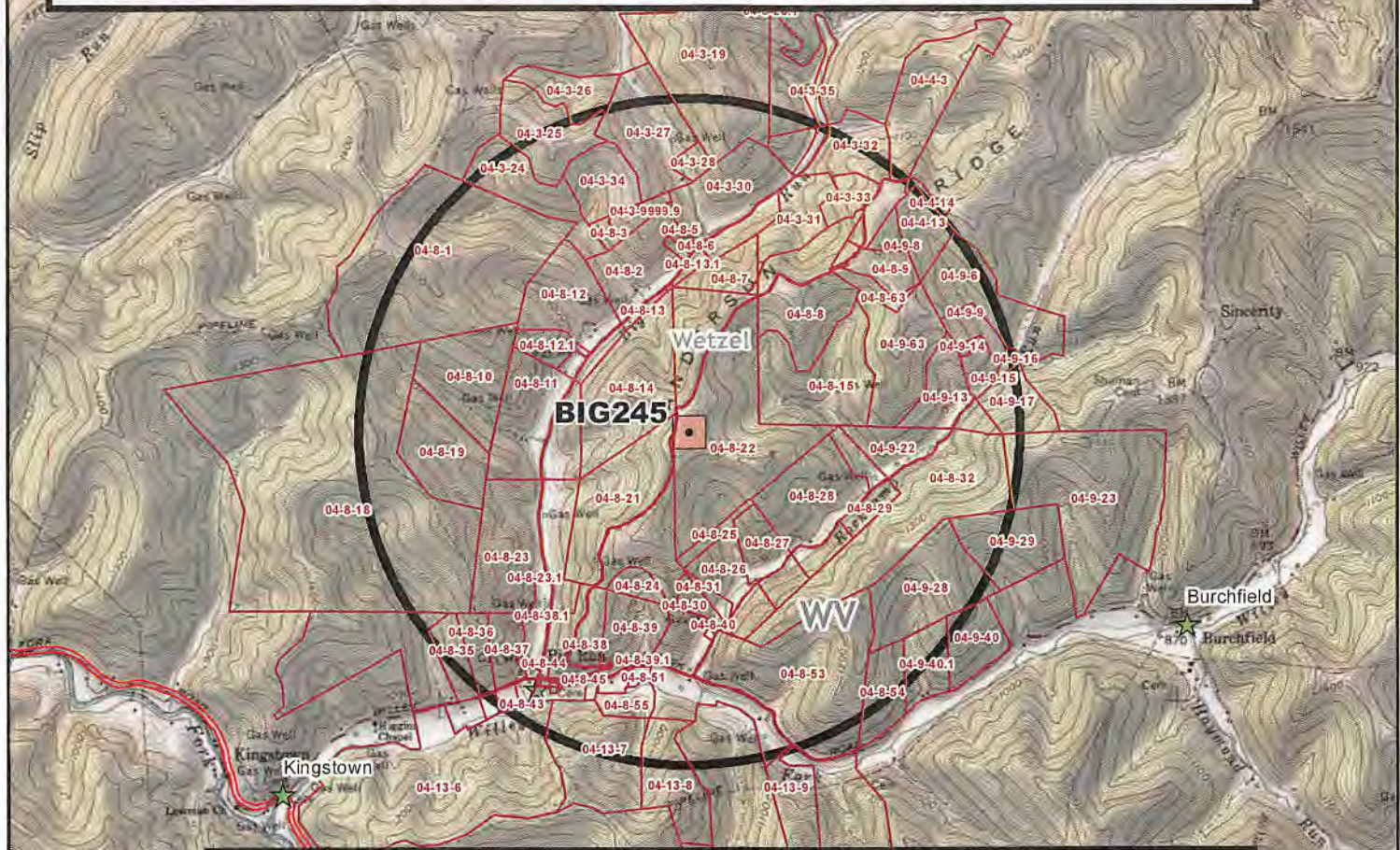

Legend

Horizontal PUD Locations	Access Routes	Railroads	College	Law Enforcement
Safety Buffer	Highways	Counties	Fire Department	Church
LANDMARKS	Interstates	Hospital	Hospital	School
Access Route	Major Roads	Streets		

RECEIVED
Office of Oil and Gas
Copyright © 2013 National Geographic Society, i-cubed

EQT
EQT Production
White Oaks Office
120 Professional Place
Bridgeport, WV 26330

Site Safety Plan

**BIG245
One Mile Safety Buffer
Wetzel County, WV**

DISCLAIMER:
ALL INFORMATION DEPICTED ON THIS MAP PROVIDED BY EQT (SAID TERM SHALL MEAN EQT PRODUCTION OR EQT MIDSTREAM, DEPENDING ON WHICH EQT ENTITY PROVIDED THE MAP), IS FOR INFORMATION PURPOSES ONLY AND SHALL BE TREATED AS CONFIDENTIAL INFORMATION AND SHALL ONLY BE USED FOR THE SOLE PURPOSE FOR WHICH IT WAS PROVIDED. ANY OTHER USE OF THIS MAP OR THE INFORMATION INCLUDED THEREON, IS STRICTLY PROHIBITED. THE EXACT LOCATION OF THE FACILITIES (INCLUDING BUT NOT LIMITED TO WELLS, PIPELINES, STRUCTURES, FACILITIES, LEASE BOUNDARIES OR ANY OTHER INFORMATION SHOWN ON THIS MAP SHALL NOT BE RELIED UPON FOR THE SPECIFIC LOCATION OF THE FACILITIES, AND THE PARTIES AGREE THAT THE INFORMATION SHOWN ON THE MAP MAY NOT HAVE BEEN PLACED ON THE MAP USING SURVEY LINES OR GPS COORDINATES. EQT MAKES NO EXPRESS OR IMPLIED REPRESENTATION OR WARRANTY AS TO THE ACCURACY OF THE MAP, OR THE INFORMATION SHOWN THEREON. THE SPECIFIC LOCATION OF ANY OF THE INFORMATION, INCLUDING ANY WELL, PIPELINE, STRUCTURE, FACILITY OR LEASE BOUNDARY, SHOULD BE DETERMINED BY A FIELD SURVEY PERFORMED BY A LICENSED SURVEYOR UPON CONSULTATION WITH EQT. THIS MAP MAY NOT BE COPIED OR OTHERWISE MADE AVAILABLE TO ANY OTHER PARTY IN PAPER OR ELECTRONIC FORMAT WITHOUT WRITTEN CONSENT FROM EQT. RECIPENT EXPRESSLY AGREES THAT ITS USE AND/OR RETAINER OF THIS MAP SHALL BE DEEMED ITS AGREEMENT TO THE TERMS SET FORTH ABOVE.

DEC 13 2018

WV Department of Environmental Protection



WV WETZEL COUNTY BIG245 SITE SAFETY PARCEL LIST

APN	OWNER	ADDR	CITY	STATE	ZIP	Phone Numbers
04-3-32	HEARTWOOD FORESTLAND	CO RT 19-1	BIG RUN	WV	26561	not listed
04-9-23	JIM C HAMER CO	CO RT 19	BIG RUN	WV	26561	not listed
04-3-33	HEARTWOOD FORESTLAND	CO RT 19-2	BIG RUN	WV	26561	304-424-3834
04-8-18	COASTAL LUMBER COMPANY	RT	BIG RUN	WV	26561	304-472-0600
04-8-48	BIG RUN CEMETERY	CO RT 19	BIG RUN	WV	26561	not listed
04-3-20.1	HEARTWOOD FORESTLAND	64 1/2 AC BIG RUN	BIG RUN	WV	26561	304-424-3834
04-3-33	HEARTWOOD FORESTLAND	CO RT 19-2	BIG RUN	WV	26561	304-424-3834
04-9-16	COASTAL LUMBER COMPANY	OFF CO RT 19-6	BIG RUN	WV	26561	304-472-0600
04-13-6	COASTAL LUMBER COMPANY	CO RT 19	BIG RUN	WV	26561	304-472-0600
04-9-14	WILLEY CEMETERY	OFF CO RT 19-6	BIG RUN	WV	26561	not listed
04-3-24	COASTAL FOREST RESOURCES CO	19-1 OFF	BIG RUN	WV	26561	304-472-0600
04-3-33	HEARTWOOD FORESTLAND	CO RT 19-2	BIG RUN	WV	26561	304-424-3834
04-8-8.1	GARNET GAS CORPORATION	OFF CO RT 19-1	BIG RUN	WV	26561	not listed
04-3-32	HEARTWOOD FORESTLAND	CO RT 19-1	BIG RUN	WV	26561	304-424-3834
04-3-31	HEARTWOOD FORESTLAND	CO RT 19-1	BIG RUN	WV	26561	304-424-3834
04-8-9.1	OAK GROVE SCHOOL	CO RT 19-2	BIG RUN	WV	26561	not listed
04-13-6	COASTAL LUMBER COMPANY	CO RT 19	BIG RUN	WV	26561	304-472-0600

RECEIVED
Office of Oil and Gas

DEC 13 2018

WV Department of
Environmental Protection

Section III: Well Work

This Attached Plan will be reviewed with all employees on the work site prior to beginning their work. Any required changes will be inserted into this Plan and made a part of the Plan after being approved by WVOOG.

Documentation

A documented EQT Tailgate Safety Meeting (TSM) Form must be completed for each shift which describes the activities occurring, possible hazards and emergency contact information. Originals must be maintained and kept with the EQT OSR and filed with the well documents to serve as verification of the meeting and communication of the shift activities.

Plan Assimilation and Dissemination

The Supervisor of Environmental and Safety - Drilling, or their designee, shall be responsible for providing a copy of this plan to the local emergency planning committee (LEPC) or county emergency services (CES) office within at least 7 days from land disturbance or well work. The LEPC or CES representative will sign a receipt (See Appendices) documenting this.

A copy of this Plan will be available in the following locations:

- In the on-site mailbox
- In the On-Site Drilling or Completions Specialist office.
- West Virginia DEP Office of Oil and Gas
- LEPC or CES
- Office of the assigned Environmental and Safety Coordinators
- Electronically in EQT *Well File Library* (as part of the permit document).

Personal Protective Equipment (PPE)

At a minimum, all personnel on-site shall wear the following PPE:

- Hardhat
- Safety glasses with side shields
- Hard toe boots

Additional PPE may be required based on unique job hazards such as:

- Flame Resistance Clothing (FRC)
- High visibility vest
- Hearing Protection

Note: Additional PPE may be assigned dependent on the site conditions and shall be the discretion of the on-site specialist and the Environmental and Safety Department. All additional PPE requirements will be communicated to all personnel.

Well Pad Construction Sequence

Basic Construction Sequence

1. Mobilization
2. Erosion & Sediment Control Install
3. Clear & Grub
4. Top soiling
5. Bulk Earthwork (Keyways to finish grade)
6. Stoning & Stabilization
7. Soundwall install (If applicable)
8. Cellar & Conductor install
9. Containment & AST install

RECEIVED
Office of Oil and Gas

DEC 13 2018

WV Department of
Environmental Protection

- 9.1. Potential Construction Hazards (29CFR 1926 OSHA Construction Industry Regulations & Standards, July 2017)
- 9.2 Fire Protection
 - 9.2.1. Fire prevention – burning on-site
- 9.3. Material Handling, Storage, Use and Disposal
 - 9.3.1. Disposal of waste material – coal, spill clean-up (hydraulic fluid, fuel)
- 9.4. Tools- Hand and Power (i.e. chainsaw for clearing)
- 9.5. Welding and Cutting
- 9.6. Motor Vehicles & Mechanized Equipment
 - 9.6.1. Material handling equipment – limited visibility
 - 9.6.2. Site clearing equipment – limited visibility
 - 9.6.3. Traffic control – off-loading equipment; cutting in entrance to new site
 - 9.6.4. Pile driving equipment
 - 9.6.5. Equipment rollovers
- 9.7. Excavations
 - 9.7.1. Sloping and benching
 - 9.7.2. Shoring for trenches
 - 9.7.3. Fall protection
- 9.8. Blasting and Use of explosives
- 9.9. Electrical
 - 9.9.1. Temporary power run to man camps
 - 9.9.2. Proper grounding
- 9.10. Confined Spaces
- 9.11. Cranes and Derricks
- 9.12. Other General Hazards (i.e. weather conditions, extreme terrain, slips, trips, etc.)

MARCELLUS/ UPPER DEVONIAN REGION:

Detail of Well Work, Drilling Operations

1. Review pertinent well data.
2. MIRU drilling rig.
3. Install riser and air bowl.
4. Drill surface or mine string hole to required depth on air / foam / water based mud.
 - a. Surface casing must be set at least 50' and no more than 150' below the deepest freshwater unless necessary to cover workable coal seams.
 - b. Mine string hole will not be drilled more than 100' below base of the mine. Casing will be set below the mine and a cement basket will be placed above the mine to allow cement to be placed from the basket to surface.
5. Run casing to program depth. Centralize per requirements.
6. Cement to surface per regulation.
7. WOC 8 hrs.
8. Pressure test casing to 20% over Maximum Anticipated Surface Pressure (MASP).
9. If separate mine string was required, prepare riser for the drilling of fresh water protective hole section as follows:
 - a. TIH with drilling assembly.
 - b. Drill out mine string and to section TD.
 - c. Run water protective string (surface casing) to prescribed depth per regulation.
 - d. Cement casing to surface per regulation.
 - e. Pressure test casing to 20% over MASP.

RECEIVED
Office of Oil and Gas

DEC 13 2018

WV Department of
Environmental Protection

- f. WOC 8 hrs.
- 10. Install and test wellhead per manufacturer's specification.
- 11. Install BOP stack.
- 12. Test BOP's
 - a. Annular Preventer to 70% of rated capacity
 - b. Ram Preventers to 80% of rated capacity
- 13. MU drilling assembly
- 14. Drill out surface casing and to planned section TD.
- 15. Run intermediate casing to programmed depth.
- 16. Cement intermediate casing to surface per regulation.
- 17. Pressure Test casing 20% over MASP.
- 18. WOC 8 hrs.
- 19. MU drilling assembly
- 20. Drill out casing. Perform formation integrity test to adequate pressure gradient.
- 21. Drilling a pilot hole:
 - a. If drilling a pilot hole to tag the Onondaga:
 - i. Drill the pilot hole to tag the Onondaga but no more than 100'.
 - ii. Trip out of hole and run open hole logs per geology.
 - iii. Trip in hole with drill pipe and plug back with solid cement plug to approximately 200' above KOP.
 - iv. Proceed to step 22.
 - b. If not drilling a pilot hole to tag the Onondaga:
 - i. Drill pilot hole to KOP.
 - ii. Trip for directional drilling assembly.
 - iii. Proceed to step 22.
- 22. MU directional assembly, TIH and drill curve and lateral section of production hole with drilling assembly changes as necessary to achieve the planned wellbore trajectory.
- 23. Run production casing to programmed depth.
- 24. Cement production casing per regulation. Planned TOC will be 500' above top producing zone.
- 25. WOC 8 hrs.
- 26. Nipple down BOP's and install tubing head. Test tubing head voids per manufacturers recommendation.
- 27. Install dry hole flange. RDMO drilling rigs.

First Stage Completion Work

- 1. Install containment as required.
- 2. Move in and rig up to run bond log from attainable total depth to above cement top and marker joint.

Fracture Stimulation

- 1. Install or expand containment as required.
- 2. Install two 10K frac valves with a flow cross between them, and a goathead with frac iron. Rig up frac iron and test surface equipment.
- 3. Open well and test production casing; open the toe popper.

RECEIVED
Office of Oil and Gas

DEC 13 2018

WV Department of
Environmental Protection

4. Rig up wire line and pump down plug and guns to perforate Stage one. Pump down operations are run under lubricator and pressure control.
5. Frac stage one.
6. Rig up wire line and pump down plug and guns to perforate subsequent stages. Pump down operations are run under lubricator and pressure control.
7. Set plug, perforate and frac subsequent stages.
8. Rig down frac equipment and secure location. Lubricate Back Pressure Valve into B section. Remove one 10K frac valve and flow cross. Install dry hole tree as second barrier.

Frac Isolation Plug Drill Out & Completions Flow Back Procedure

1. Install annular bop, pipe and blind rams. Rig up Snubbing unit and service rig, or coiled tubing unit. Install flow cross and flow back equipment and pressure test. Remove back pressure valve.
2. Run in hole with tubing and bottomhole assembly and drill all plugs. Returns are taken to the gas separator, gas buster and/or tanks/pits. Gas is sent down sales line or flared. Pressures are maintained at levels below the operating pressure of snubbing unit components.
3. Rig down snubbing unit and rig or coiled tubing unit.
4. Flow back well with gas to sales or flare until well is stabilized.
5. Install Back pressure valve and remove frac valves. Install production tree and lubricate out Back pressure valve. Turn over to production.

Production Operations

1. Install containment, production equipment, metering equipment, and tankage per program.
2. Test safety systems.
3. Turn well to sales.

UTICA REGION:

Detail of Well Work, Drilling Operations

1. Review pertinent well data.
2. MIRU drilling rig.
3. Install riser and air bowl.
4. Drill surface hole to required depth on air / foam / water based mud.
 - a. Surface casing must be set at least 50' below the deepest fresh water.
5. Run casing to programed depth. Centralize per requirements.
6. Cement to surface per regulation.
7. WOC 8 hrs.
8. Pressure test casing to 20% over Maximum Anticipated Surface Pressure (MASP).
9. TIH with drilling assembly.
10. Drill out surface casing string and drill to Intermediate 1 TD.
11. Run intermediate 1 casing string to prescribed depth per regulation.
12. Cement casing to surface per regulation.
13. Pressure test casing to 20% over MASP.
14. WOC 8 hrs.

RECEIVED
Office of Oil and Gas

DEC 13 2018

WV Department of
Environmental Protection

15. Install and test wellhead per manufacturer's specification.
16. Install BOP stack.
17. Test BOP's
 - a. Annular Preventer to 70% of rated capacity
 - b. Ram Preventers to 80% of rated capacity
18. MU drilling assembly
19. Drill out intermediate 1 casing and to Intermediate 2 TD.
20. Run intermediate 2 casing to programmed depth.
21. Cement intermediate 2 casing to 500' above shallowest producing zone per regulation.
22. Pressure Test casing 20% over MASP.
23. WOC 8 hrs.
24. MU drilling assembly
25. Drill out casing. Perform formation integrity test to adequate pressure gradient.
26. Drill pilot hole to 200' below Trenton formation.
27. TOOH and run logs per geology.
28. TOOH with logging tools and TIH with drill pipe. Set cement plug back to KOP.
29. TOOH for directional drilling assembly.
30. MU directional assembly, TIH and drill curve and lateral section of production hole with drilling assembly changes as necessary to achieve the planned wellbore trajectory.
31. Run production casing to programmed depth.
32. Cement production casing 1000' above KOP per regulation.
33. WOC 8 hrs.
34. Nipple down BOP's and install tubing head. Test tubing head voids per manufacturers recommendation.
35. Install dry hole flange. RDMO drilling rigs.

First Stage Completion Work

1. Install containment as required.
2. Install 15K frac valve
3. Move in and rig up WL to run bond log from attainable total depth to above cement top and marker joint.

Fracture Stimulation

1. Install or expand containment as required.
2. Install two 15K frac valves with a flow cross between them, and a goathead with frac iron. Rig up frac iron and test surface equipment.
3. Open well and test production casing; open the toe popper (if toe popper is run).
4. Rig up wire line and pump down plug and guns to perforate Stage one, or use WL tractor or CT. Pump down operations are run under lubricator and pressure control.
5. Frac stage one.
6. Rig up wire line and pump down plug and guns to perforate subsequent stages. Pump down operations are run under lubricator and pressure control.
7. Set plug, perforate and frac subsequent stages.
8. Rig down frac equipment and secure location. Lubricate Back Pressure Valve into B section. Remove one 15K frac valve and flow cross. Install dry hole tree as second barrier.

RECEIVED
Office of Oil and Gas

DEC 13 2018

WV Department of
Environmental Protection

Frac Isolation Plug Drill Out & Completions Flow Back Procedure

1. Install annular bop, pipe and blind rams. Rig up Snubbing unit and service rig, or coiled tubing unit. Install flow cross and flow back equipment and pressure test. Remove back pressure valve.
2. Run in hole with tubing and bottomhole assembly and drill all plugs. Returns are taken to the gas separator, gas buster and/or tanks/pits. Gas is sent down sales line or flared. Pressures are maintained at levels below the operating pressure of snubbing unit components.
3. Rig down snubbing unit and rig or coiled tubing unit.
4. Flow back well with gas to sales or flare until well is stabilized.
5. Install Back pressure valve and remove frac valves. Install production tree and lubricate out Back pressure valve. Turn over to production.

Production Operations

1. Install containment, production equipment, metering equipment, and tankage per program.
2. Test safety systems.
3. Turn well to sales.

RECEIVED
Office of Oil and Gas
DEC 13 2018
WV Department of
Environmental Protection

Section IV: Chemical Inventory & SDS

Safety Data Sheets (SDS):

SDS for all materials and chemicals on-site will be maintained and readily available at the well site. Copies of these SDS will be kept in the EQT On-site Offices, or be available on-line and be the responsibility of the EQT On-site Specialist. An electronic copy of the Anticipated SDS will be submitted to the Department as well.

Mud Information

There will be one induction style mud hopper on location for mixing the fluid.

Mud Usage Marcellus/Upper Devonian Region		Mud Usage Utica Region	
Mix Mud Amount	2000 – 3500 bbls	Mix Mud Amount	2000 – 3500 bbls
Mud Weights	8.5 – 14.8 ppg	Mud Weights	8.5 – 18.5 ppg
Volume Mixing Water	275 – 2750 bbls	Volume Mixing Water	275 – 2750 bbls

RECEIVED
Office of Oil and Gas

DEC 13 2018

WV Department of
Environmental Protection

Below table contains the inventory of on-site materials for mixing mud.

Product Name	General Description	Possible Inventory	Package Size
ALDACIDE G	Bacteria prevention	0 – 32	5 gallon can
BARABLOK	Fluid loss additive	0 – 100	50 lbs. sack
BARACARB 50, 150, 600	Lost circulation material	0 – 150	50 lbs. sack
BARACOR 700	Corrosion inhibitor	0 – 4	55 gallon drum
BARA-DEFOAM W300	Mud defoamer	0 – 32	5 gallon can
BARAZAN-D PLUS	Viscosifier	0 – 80	25 lbs. sack
BAROFIBRE	Lost circulation material	0 – 100	25 lbs. sack
BAROID 41	Weighting agent	0 – 80	Bulk tons
BARO-SEAL COARSE	Lost circulation material	0 -100	50 lbs. sack
Bicarbonate of soda	Calcium control	0 – 49	50 lbs. sack
Calcium chloride powder	Salinity control	0 – 160	50 lbs. sack
Caustic soda	pH/alkalinity control	0 – 25	50 lbs. sack
Citric acid	pH/alkalinity control	0 – 25	50 lbs. sack
DEXTRID LT	Fluid loss additive	0 – 100	50 lbs. sack
DRILTREAT	Wetting agent/emulsifier	0 – 16	5 gallon can
EZ-MUD	Shale inhibitor	0 – 10	5 gallon can
GELTONE V	Viscosifier	0 – 50	50 lbs. sack
LE SUPERMUL	Emulsifier	0 – 16	55 gallon drum
Lime	pH/alkalinity control	0 – 50	50 lbs. sack
N-SEAL	Lost circulation material	0 – 100	50 lbs. sack
NXS-LUBE	Lubricant	0 – 16	5 gallon can
OMC 42	Mud conditioner	0 – 4	55 gallon drum
PAC-L	Fluid loss additive	0 – 80	50 lbs. sack
QUIK-THIN PLUS	Mud thinner	0 – 100	50 lbs. sack
RHEMOD I	Mud conditioner	0 – 8	55 gallon drum
RM 63	Mud conditioner	0 – 8	55 gallon drum
Soda Ash	Calcium control	0 – 25	50 lbs. sack
Sodium chloride	Salinity control	0 – 30	2,000 lbs. sack
STEELSEAL 400	Lost circulation material	0 – 200	50 lbs. sack
SUSPEMPTONE	Suspension agent	0 – 100	50 lbs. sack
SynOil	Base oil	0 – 150	bbbls (42 gal)
WALL-NUT MEDIUM	Lost circulation material	0 – 150	50 lbs. sack
ZEOGEL	Viscosifier	0 - 100	50 lbs. sack

RECEIVED
Office of Oil and Gas

DEC 13 2018

WV Department of
Environmental Protection

Section V: BOP and Well Control**BOP equipment and assembly installation schedule**

BOP Equipment – Marcellus/Upper Devonian Region						
Size (in)	Operation	Hole Section	Type	Pressure Class	Test Pressure (psi)	Test Frequency
13-5/8"	Drilling	Intermediate	Annular	3M	2,100	Initial
13-5/8"	Drilling	Pilot	Annular	3M	2,100	Initial, Weekly, Trip
13-5/8"	Drilling	Production	Annular	5M	3,500	Initial, Weekly, Trip
13-5/8"	Drilling	Production	Blind	5M	4,000	Initial, Weekly, Trip
13-5/8"	Drilling	Production	Pipe	5M	5,000	Initial, Weekly, Trip
7-1/16"	Completions	Production	Cameron U's	5M	5,000	Initial
13-5/8"	Drilling	Pilot (Onondaga Tag)	Annular	5M	4,000	Initial, Weekly, Trip

Wellhead Detail – Marcellus/Upper Devonian		
Size (in)	Type	M A W P (psi)
13-3/8" SOW x 13 5/8" 5M	Multi-bowl Well Head	5,000
13-5/8" 5M x 7-1/16" 10M	Tubing Head	10,000
2-1/16" 5M	Christmas Tree	5,000

Utica Region

Test BOPs as follows:

- Annular to 250 psi low/2,100 psi high for 30 mins each
- All ram, choke/kill valves, TIW, IBOP and all choke manifold valves to 250 psi low/4,000 psi high for 30 mins each
- Annular to 250 psi low/3,500 psi high for 30 mins each
- All ram, choke/kill valves, TIW, IBOP and all choke manifold valves to 250 psi low/8,000 psi high for 30 mins each

RECEIVED
Office of Oil and Gas

DEC 13 2018

WV Department of
Environmental Protection

BOP Equipment – Utica Region						
Size (in)	Operation	Hole Section	Type	Pressure Class	Test Pressure (psi)	Test Frequency
13 5/8"	Drilling	Intermediate	Annular	3M	2,100	Initial, Weekly, Trip
13 5/8"	Drilling	Intermediate	Pipe	5M	4,000	Initial, Weekly, Trip
13 5/8"	Drilling	Intermediate	Blind	5M	4,000	Initial, Weekly, Trip
13 5/8"	Drilling	Pilot/Production	Annular	5M	3,500	Initial, Weekly, Trip
13 5/8"	Drilling	Pilot/Production	Pipe	10M	8,000	Initial, Weekly, Trip
13 5/8"	Drilling	Pilot/Production	Blind	10M	8,000	Initial, Weekly, Trip

Wellhead Detail – Utica		
Size (in)	Type	M A W P (psi)
13-3/8" SOW x 13-5/8" 10M	Multi-bowl Well Head	10,000
13 5/8" 10M x 7 1/16" 15M	Tubing Head	15,000
2 9/16" 10M	Christmas Tree	15,000

Well Control Trained Personnel:

Drilling

- EQT On-Site Specialist – 2 on rotating hitches.
- Contract Group's – Tool Pusher & Drillers

Completions & Production

- EQT On-Site Specialist or Consultant

Notification Procedure

Significant Event Notifications

- A detailed record of significant drilling events will be recorded in the EQT Production Well Log Book.
- In addition to the record above, the local inspector of the WV DEP Office of Oil and Gas and Supervisor of EH&S will be notified by the EQT On-Site Specialist for the following events:
 - Lost Circulation
 - Encounter of Hydrogen Sulfide Gas
 - Immediate notification is required of any reading of Hydrogen Sulfide Gas greater than 10ppm
 - Fluid Entry
 - Abnormal Pressures
 - Blow-outs
 - Significant kicks
- Contact information can be found in Section II

Emergency Notifications

- In the event emergency response personnel and residents surrounding the work site are affected by specific events during the operation they must be notified as soon as possible by the On-site Specialist or their designee.

Flaring Notifications

- The local fire department(s) and/or county dispatch centers must be notified immediately prior to the ignition of a flare.

RECEIVED
Office of Oil and Gas

DEC 13 2018

WV Department of
Environmental Protection

Marcellus/Upper Devonian Region Well Head Assembly Design, version 1.

Written Description:

Multi-bowl wellhead assembly with a 13 3/8" 5M x 13 3/8" SOW wellhead. A 13 5/8" 5M x 11" 5M DSA is used between the wellhead and tubing head. The tubing head is 11" 5M x 7 1/16" 10M. The tree is 2 1/16" 5M. Picture of stack up below.

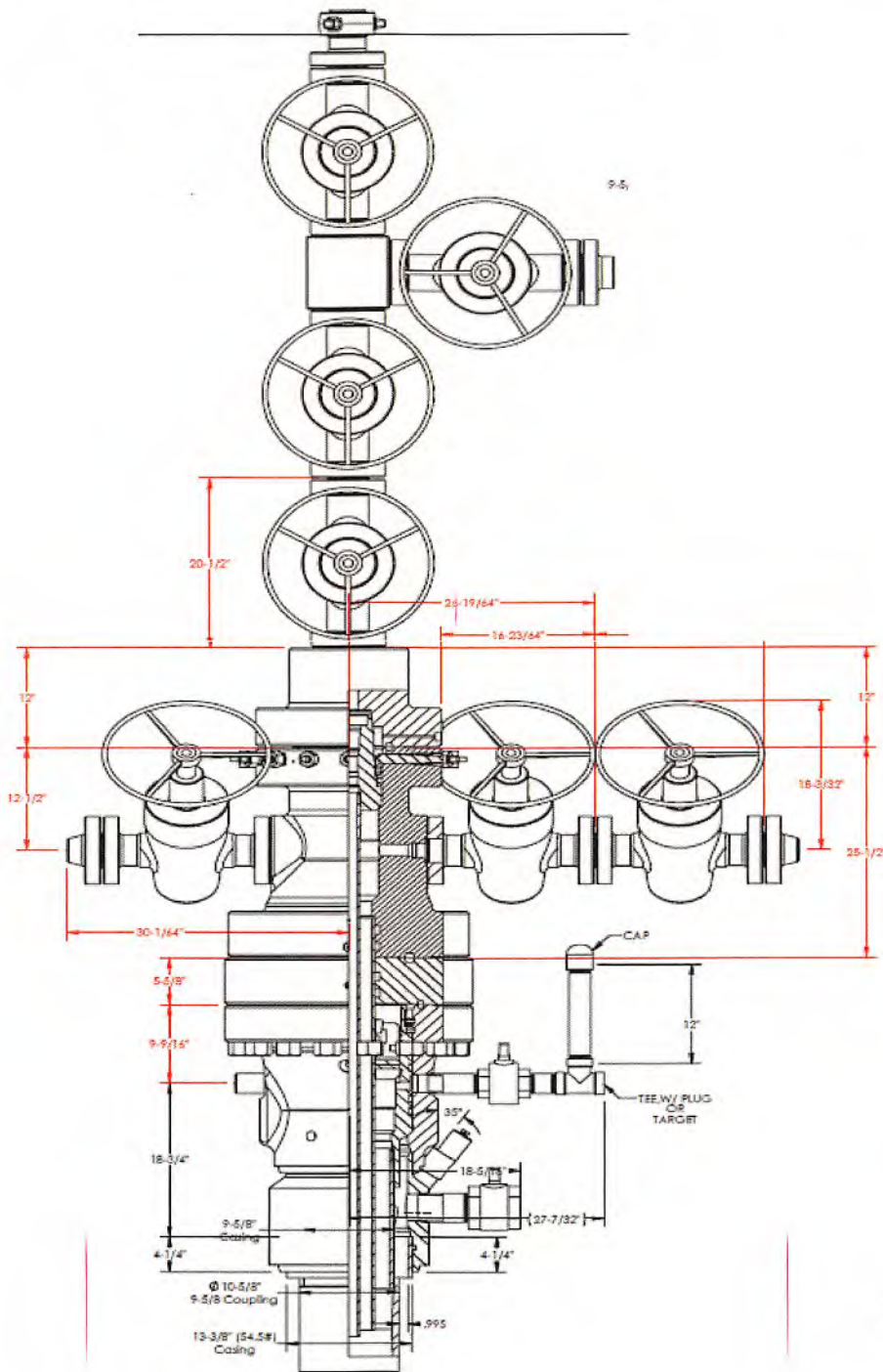

RECEIVED
Office of Oil and Gas

DEC 13 2018

WV Department of
Environmental Protection

Marcellus/Upper Devonian Region Well Head Assembly Design, version 2.

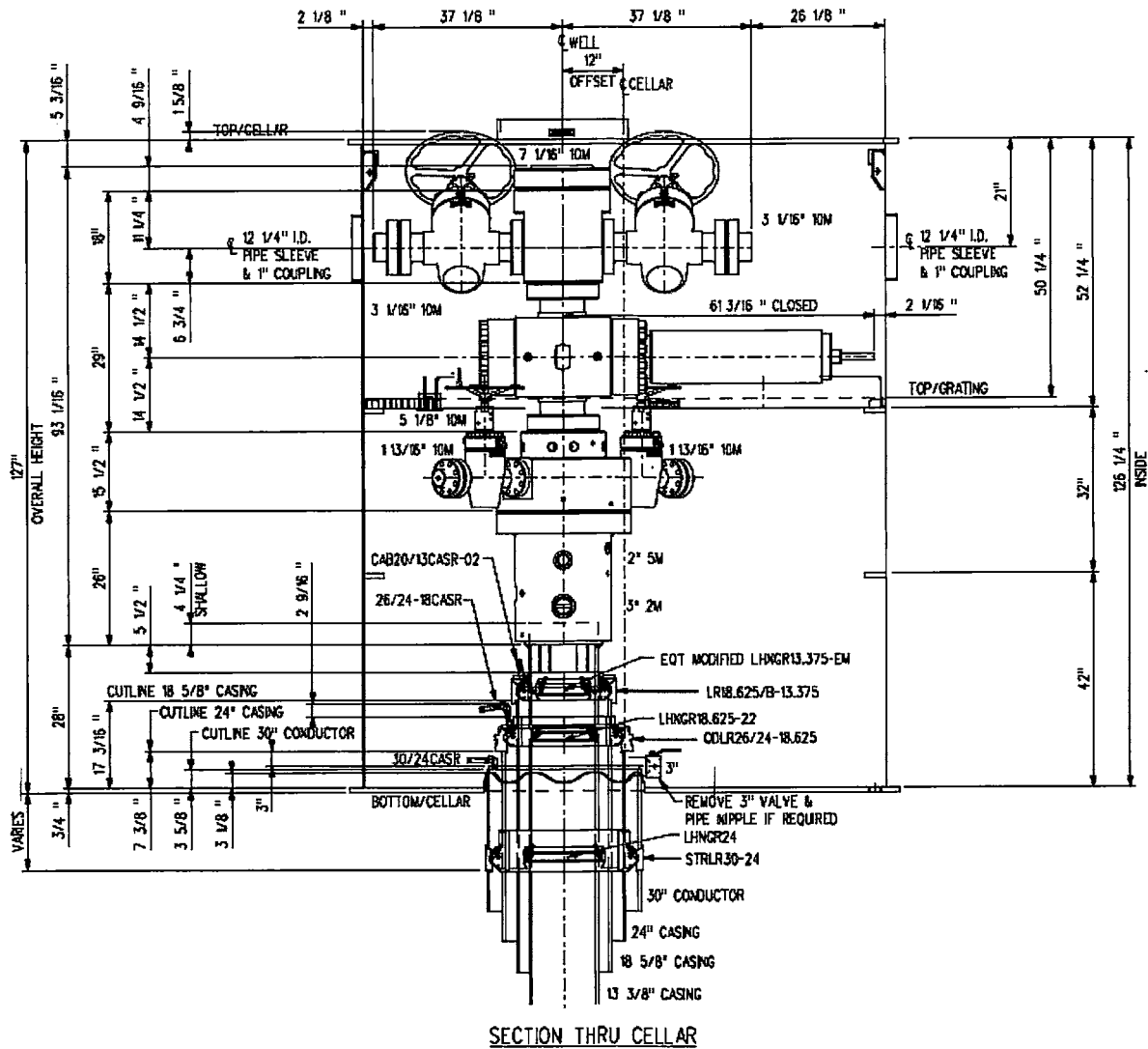

SECTION THRU CELLAR

COP110817 © 2017 CELLAR TECH, LLC. PATENT # 8,932,412		DRAWING ISSUED DATE: 01/08/17		CELLAR TECH CONTAINMENT WELL CELLAR SYSTEMS EQT PRODUCTION MODEL: EQT - 10872127-26-02	
THIS DRAWING CONTAINS PROPRIETARY INFORMATION AND TECHNOLOGY OF CELLAR TECH, LLC. ANY PERSON VIEWING THIS DRAWING AGREES TO KEEP ALL INFORMATION CONTAINED HEREIN CONFIDENTIAL. THIS INFORMATION SHALL NOT BE REPRODUCED OR DISCLOSED TO ANY OTHER INDIVIDUAL OR ENTITY WITHOUT THE WRITTEN CONSENT OF AN OFFICER OF CELLAR TECH, LLC. THIS DRAWING MAY ALSO BE PROTECTED BY CELLAR TECH, LLC PATENTS.		REFERENCE <input type="checkbox"/> PROGRESS <input type="checkbox"/> PRELIMINARY <input type="checkbox"/> APPROVAL <input type="checkbox"/> DESIGN <input type="checkbox"/> MATERIAL <input type="checkbox"/> CONSTRUCTION <input type="checkbox"/> REVISION <input type="checkbox"/> AS BUILT			
11/08/17 REF		DATE: 01/08/17 SCALE: 3/4"=1'-0" BY: REC		CELLAR TECH DRAWING NUMBER EQT-SK-110817-1	
A 11/08/17 REC ISSUED FOR REFERENCE		DATE: 01/08/17 SCALE: 3/4"=1'-0" BY: REC	APPR: JR CHD: z CODE: CT-057		

RECEIVED
Office of Oil and Gas

DEC 13 2018

WV Department of
Environmental Protection

Utica Region Well Head Assembly Design

Written Description:

Multi-bowl wellhead assembly with a 13 5/8" 10M x 13 3/8" SOW wellhead. A 13 5/8" 10M x 7 1/16" 15M DSA is used between the wellhead and tubing head. The tubing head is 7 1/16" 15M x 7 1/16" 15M. The tree is 2 9/16" 15M. Picture of stack up below.

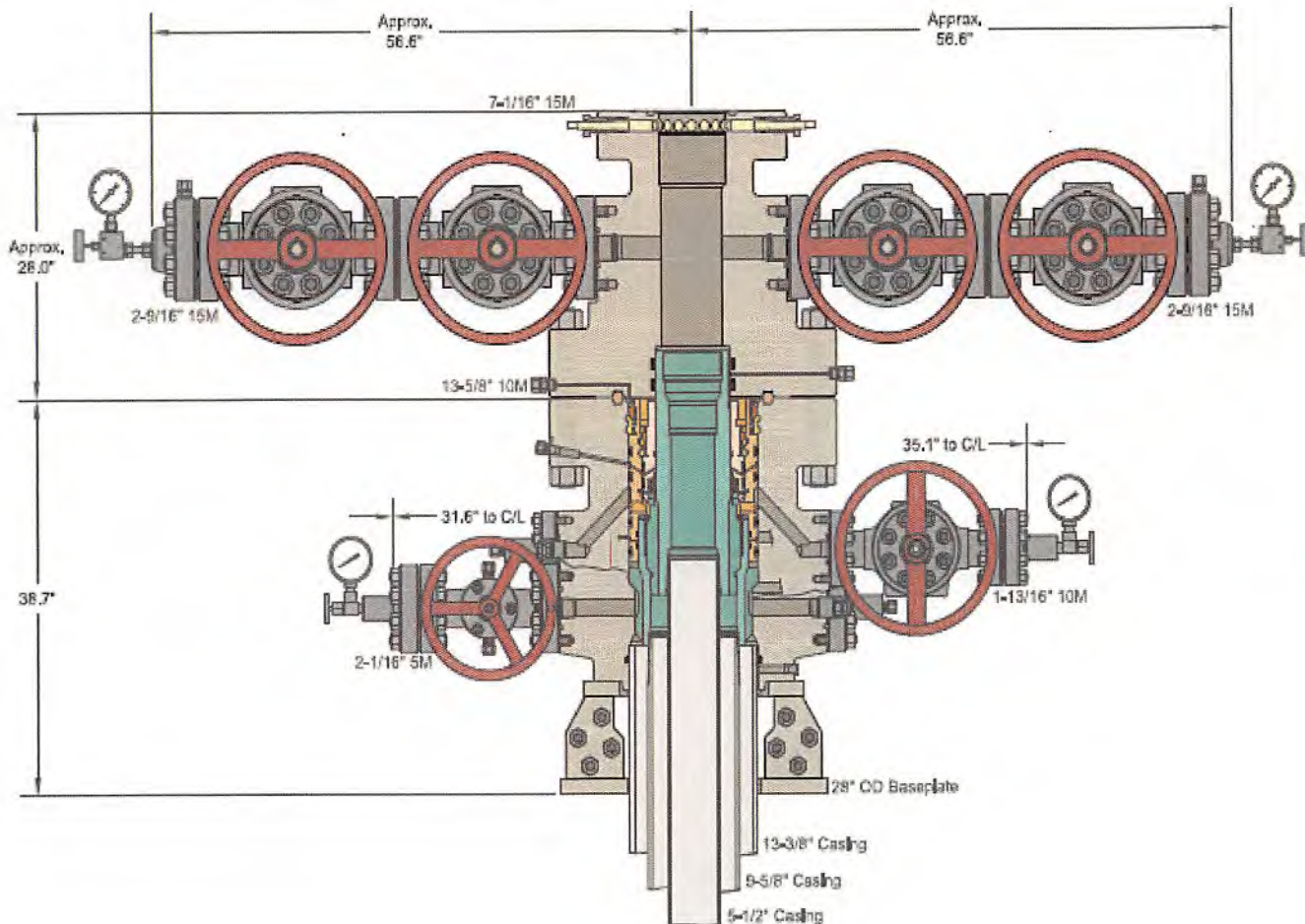

RECEIVED
Office of Oil and Gas

DEC 13 2018

INFORMATION CONTAINED HEREIN IS THE PROPERTY OF CACTUS WELLHEAD, LLC. REPRODUCTION, DISCLOSURE, OR USE THEREOF IS PERMISSIBLE ONLY AS PROVIDED BY CONTRACT OR AS EXPRESSLY AUTHORIZED BY CACTUS WELLHEAD, LLC.

WV Department of Environmental Protection

CACTUS WELLHEAD LLC

**EQT PRODUCTION
NORTHEAST**

13-3/8" X 9-5/8" X 5-1/2" MBU-2LR Wellhead Assembly
With 13-5/8" 10M x 7-1/16" 15M CTH-DBLHPS Tubing Head
& 2-9/16" 15M Tubing Head Valves

DRAWN	DLE	04NOV15
APPRV		
DRAWING NO.	DNE0000013	

Well Kill Killing Operations

In a well control situation, all influxes are to be handled using the Wait-and-Weight Method or the Driller's Method. With the Wait-and-Weight Method, the influx is circulated out while kill weight mud is simultaneously circulated down the drill pipe and up the annulus. The heavy mud is circulated to the bit at a slow kill rate, and the drill pipe pressure is maintained according to a prepared table that gives drill pipe pressure for the corresponding strokes of kill mud pumped.

The Driller's Method is accomplished in two circulations using constant drill pipe pressure and maintaining constant pump speed. The drill pipe pressure is kept constant by adjusting the choke. Once the annulus is clear of the influx, the mud weight is adjusted to kill-weight. The kill-weight mud is then circulated to the bit using constant pump speed and drill pipe pressure step-down plan. When kill-weight mud has reached the bit, the FCP is maintained until the heavy mud has reached the surface.

RECEIVED
Office of Oil and Gas
DEC 13 2018
WV Department of
Environmental Protection

Section VI: Hydrogen Sulfide

Purpose

The purpose of this plan is to insure the safety of the all on-site personnel as well as those residents in close proximity. Hazards associated with the possibility of H₂S encounters and the warning signs of H₂S exposure will be covered.

Scope

The policy is to consider every encounter with H₂S as potentially lethal until proven otherwise. Upon encountering H₂S, EQT employees or contractors(s) will determine the concentration of H₂S.

General Information

Immediately upon suspicion or odor of H₂S on location, the concentration shall be determined using properly functioning single or multi-gas detection devices which have a sensor calibrated to detect the presence of H₂S gas.

- All readings should be documented along with the time they were obtained
- All areas having a reading of greater than 10 ppm H₂S shall be evacuated until the area has been cleared of H₂S, or properly trained personnel equipped with appropriate PPE arrive on location.
- H₂S deadens the sense of smell; the presence or absence of H₂S odor is not an acceptable means for determining the presence of gas.
- Never walk upwind or uphill towards any suspected source of H₂S; approach using a cross wind approach.

Identify wind direction and evacuate personnel upwind and uphill of the leak; H₂S is heavier than air and will settle in low-lying areas.

If necessary, the well will be shut in and the work will be stopped until adequate safety personnel and equipment have arrived on site.

No work will take place until the appropriate personnel and equipment are in place.

The primary considerations at this time will be:

- H₂S concentration
- Gas Volume
- Weather Conditions
- Dwellings in the area.

Personal Protective Equipment

1. The EQT H₂S contractor will have an emergency trailer with SCBA's, additional gas detection equipment and other instrumentation and PPE required for appropriate response.
2. All personnel on location; all personnel monitoring adjacent to the location; or all personnel associated with the operation, will be equipped with personal H₂S monitors.
3. There will be a H₂S monitor located at the flow line exit, during the drilling of this well, as well as on the Rig Floor.
4. This PPE shall be in addition to the PPE requirements listed in EQT's General Safety Policies and Procedures.

RECEIVED
Office of Oil and Gas
DEC 13 2018
WV Department of
Environmental Protection

Training

Only personnel whom have been properly trained; or are qualified in the hazards of H₂S, will be allowed on location during operations that have encountered, or projected to encounter H₂S.

- There will be a safety briefing prior to start of each shift or tower and hazards and currently readings of H₂S will be documented on a TSM or JSA.

Personnel Accountability and Briefing (Assembly) Areas

The sign in sheet of the EQT Tailgate Safety Meeting (TSM) Form shall be used for Accountability of on-site personnel as well as visual confirmation with the current supervisor of the site. Personnel should not leave the site without first informing their immediate supervisor, Emergency Coordinator, and/or On-Site Representative (OSR).

- The sign in roster is located at: **EQT Company Trailer**
- Primary Assembly Area: **EQT Company Trailer**
- Secondary Assembly Area: **Access road intersection with pad entry**
- Tertiary Assembly Area: **Start of the access road or a safe location chosen based on conditions.**

Specific considerations for H₂S should include:

- Windssocks or streamers for indication of wind direction.
- Being upwind of harmful levels of H₂S
- Avoiding low lying areas

Signage will be utilized along the location road, or any other entrances to the location, if H₂S is encountered.

H₂S Response Team Contractors

- The designated EQT Hydrogen Sulfide Emergency Response Company will be determine based on availability, location of the incident and master service agreements maintained by EQT.

Emergency numbers

- See Section I for emergency contact information.

Site Access

- See Section II: Site Access for information.

Notifications

The EQT H₂S Contractor will be notified at the following intervals if operations are occurring on a suspected H₂S location:

- Pre-Spud Meeting
- Spud Date
- Bottom of 9 5/8"
- 1000' Above Onondaga

Protection Zone Plans

Emergency Protection Zone Plan

In the event of an emergency on the well site, the Emergency Coordinator, or his designee, shall determine protective zones to limit the risk of exposure to workers, local responders, and residents surrounding the work area.

- The attached Safety Zone Map and Parcel Owners listed in Section II of this plan can be utilized.

Life safety, impacts to the environment, and property conservation are priorities.

The Emergency Coordinator shall determine these zones based on the following information on the scene:

- Magnitude of the incident
- Wind Direction
- MSDS of applicable materials
- Current and forecasted weather conditions
- Topography and land conditions
- Other influences specific to the incident

Once established, these zones will be maintained until a determination is made by the Emergency Coordinator to alter or discontinue them.

Flowback Condensate Protection Zone Plan

A pre-job meeting or contact will be performed with all parties prior to startup.

Equipment and operational guidelines are:

- Permit entry only 30' radius around gas buster tanks.
- Signs posted around well site.
- Gas detectors and condensate sticks will be on location and used.
- Approved vendors only for condensate transfer to pre-approved sites.
- Emergency response plan reviewed for either WV or PA operations.
- EQT On-Site Completion Specialist (OCS) will be notified immediately of any liquids on the ground.
- Only approved companies and vacuum trucks to be used to pick up fluids.
- LEL meter usage verified and to be checked.
- All ignition sources around well site will be reviewed.

RECEIVED
Office of Oil and Gas

DEC 13 2018

WV Department of
Environmental Protection

Section VII: Flaring

Flaring Operations

Drilling

Flare Line Installation

The BOP equipment will all be located on the surface. The choke line coming off the stack will lead into a 5,000 psi choke manifold with 2 adjustable chokes. The 7" blooie line will divert any gas 50-75' away from rig substructure. Blooie line will be properly anchored with stakes or buried and will be set up so that gas can be vented. There will be a clearing of 25' for the gas to be vented. Duration of flare is expected to be ~ 7 days, depending on actual test results.

Ignition Methods

1. Primary – Vent
2. Backup – Marine flare pistol

Notification

Notification of a Flare will be given to the local Fire Department and/or 911 center, if possible. Refer to Section 3.0 for contact information.

Completions

Flare Line Installation – Marcellus/ Upper Devonian Region

The Flare Stacks will be positioned in a safe area at least 25' away from pit liners, trees and any other hazardous sites. The Flowback configuration consist of in order: 7 and 1/16" 10m frac valve; Flow Cross with 4 and 1/16" wing valve ; junk catcher; choke manifold; 1440 psi or 2000 psi horizontal test separator and 2" 206 pipe to Flare Stack. Flowline will be properly anchored and tethered. Duration of flare is expected to be ~ 7 days, depending on actual test results.

Ignition Methods

1. Primary –Pilot Light

Flare Line Installation – Utica Region

The Flare Stacks will be positioned in a safe area at least 25' away from pit liners, trees and any other hazardous sites. The Flowback configuration consist of in order: 7 and 1/16" 10m frac valve; Flow Cross with 4 and 1/16" wing valve ; junk catcher; choke manifold; 1440 psi or 2000 psi horizontal test separator and 2" 206 pipe to Flare Stack. Flowline will be properly anchored and tethered. Duration of flare is expected to be ~ 7 days, depending on actual test results

Ignition Methods

1. Primary –Pilot Light

Notification

Notification of a Flare will be given to the local Fire Department and/or 911 center, if possible. Refer to Section II for contact information.

02/08/2019

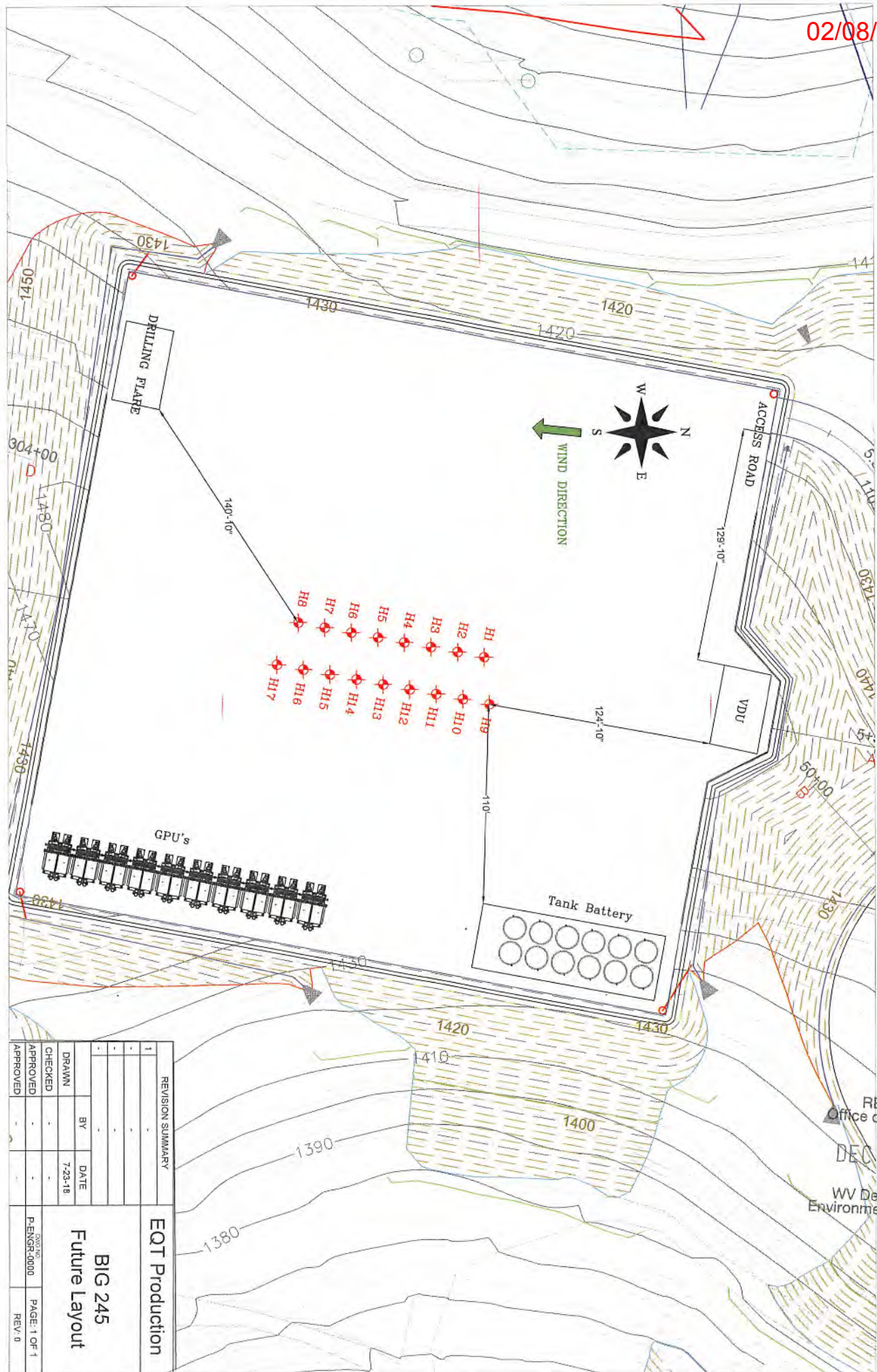

REVISION SUMMARY		DATE		BY	
1					
	DRAWN	7-23-18			
	CHECKED				
	APPROVED				
	APPROVED				

EQT Production		BIG 245	
Future Layout		PAGE: 1 OF 1	
P-ENGR-0000		REV: 0	

RECEIVED
Office of Oil and Gas
DEC 13 2018
WV Department of
Environmental Protection

Section VIII: Collision Avoidance

Collision avoidance is managed by utilizing gyro tools, downhole steering tools (MWD/EM), and anti-collision software by engineers. Two drilling scenarios that occur are normal pad drilling and return to pad drilling. EQT categorizes these two scenarios as such because the two scenarios utilize very different mitigation plans.

Normal pad drilling is defined when a top hole rig drills each well on the pad down to kick off point (KOP) and then a bottom hole rig moves onto the pad after the top-hole rig moves off and drills the curve and lateral sections. Normal pad drilling can also be defined when a bottom hole rig moves to a pad and drills each well on the pad from surface to TD (Grassroots Well). Normal pad drilling carries much less risk and thus does not require frequent surveying and collision avoidance maneuvers because no producing wells are present and risk of unexpected pressure or well control events are not present.

Return to pad drilling is a scenario where a top-hole rig or a bottom hole rig returns to a pad to drill additional well(s) that currently have producing (live) wells on the pad. Return to pad drilling requires more frequent surveying and anti-collision avoidance management because producing wells are present. By utilizing good engineering well design, anti-collision software and frequent surveys, wells can safely be drilled while existing or producing wells exist on the pad.

With both normal and return to pad drilling operations, every well planned to be drilled has a surface plot diagram, 2-D plot diagram, and a pad plot diagram prepared. (Plots attached under "Collision Avoidance Diagrams") In each scenario, a continuous north seeking gyro tools, MWD/EM tools, and anti-collision processes are utilized to mitigate the risk of downhole collisions. Anti-collision processes include conformation of gyro accuracy, evaluation of anti-collision software (Compass or equivalent program), and 2-D/3-D model plotting. In both scenarios, it is EQT's standard operating procedure (SOP) for the on-site supervisor of EQT and the directional drilling company supervisor to confirm the orientation of the directional tools and ensure that the tools are orientated consistent with the directional motor's high side. When anti-collision is a risk and directional assemblies are required to navigate utilizing a gyro tool, it is EQT's SOP to use the Gyro company's muleshoe to ensure the accuracy of the gyro seat in the muleshoe. In addition, when using this muleshoe, it is EQT's SOP to have the EQT's on-site supervisor, directional drilling company supervisor, and gyro company supervisor confirm the alignment and orientation of the tool and ensure that the tools are orientated consistent with the directional motor's high side. This ensures the azimuthal direction is correct when steering the well.

Normal Pad Drilling

In this scenario, there are no existing wells on the pad. A top-hole rig will move on to the pad and drill each well to KOP and then a bottom hole rig will move on after the top hole rig finishes and drill the each well to horizontal TD. At times, the bottom hole rig may drill each well from surface to horizontal TD.

During this scenario, if two wells come within 10 feet or a separation factor of 1.5, each survey is monitored closely and anti-collision is run after each survey until the wells are clear of a collision risk. The frequency of surveys can vary from 30-500' depending on the trajectory of the wells, hole walk, and risk of collision. If a $SF \leq 1.0$ or $\leq 5'$ separation is encountered or a collision occurs, an email notification will be sent by the EQT on-site drilling supervisor to the appropriate state inspector. In the event the proximity of wells get to a point where a collision cannot be avoided or a collision occurs, EQT will properly secure each well and evaluate the most prudent plan forward while communicating plans with the state inspector.

Vertical Section:

Each hole is drilled to KOP by either the top-hole rig or bottom hole rig. Once KOP is achieved then a gyro survey is run. No nudges are planned.

- Each gyro is analyzed and certified accurate by the gyro company before it is used for any directional planning or modeling. Each tool is roll tested on location and if all surveys are within tolerances the gyro survey is sent to the gyro company's office to be further analyzed and certified accurate.

Horizontal Section:

After the top-hole section of the well is complete and the well is at KOP, anti-collision is run on each well and the most efficient well path with the lowest risk of collision is selected by engineers. Directional bottom hole assemblies (BHA) are run in the hole and used to drill the well from vertical to horizontal. Gyros or MWD/EM surveys are taken as needed to steer the well until the well is away from the other wells and the risk of collision is eliminated. Surveys utilizing MWD/EM tools are taken from that point on to the total depth of the well is achieved. After each survey is taken, the surveys are analyzed by both EQT engineers and the directional drilling well planning technicians and anti-collision is run to ensure current well path is not in the direction of a producing well(s) and consistent with the permitted well path.

- Anti-Collision is a software program into which gyro surveys or MWD/EM surveys are uploaded. The software runs 2-D and 3-D well paths of all wells within the vicinity of the well being drilled.
- Surveys are taken every 30-100'.
- While directionally drilling the well, anti-collision software is constantly updated and separation factors (SF) are analyzed.
- Each survey is analyzed and certified accurate by the directional company before it is used for any directional planning or modeling.

Return to Pad Drilling

In this scenario a top-hole rig or bottom hole rig will move on a pad that currently has producing (live) wells on the pad. Prior to drilling additional wells on the pad, the gyro from the existing wells on the pad are analyzed by engineers to evaluate how the existing wells walk in the vertical part of the well. Then preliminary directional plans are prepared to mitigate downhole collisions. EQT plans to drill and develop the pad while producing existing offset wells. However, additional well path management (more frequent surveying and anti-collision modeling) is performed by engineers during the drilling process both in the vertical and horizontal sections of each well.

During this scenario, the well is surveyed from surface to TD as it is drilled and if two wells come within 14 feet or a SF of 2.0, each survey is monitored closely and anti-collision is run after each survey until the wells are clear of a potential collision. The frequency of surveys can vary from 30-500' depending on the trajectory of the wells, hole walk, and risk of collision. If a $SF \leq 1.0$ or $\leq 5'$ separation is encountered, an email notification will be sent by the EQT on-site drilling supervisor to the appropriate state inspector. In the event the proximity of wells get to a point where a collision cannot be avoided, EQT will properly secure each well and evaluate the most prudent plan forward while communicating plans with the state inspector.

RECEIVED
Office of Oil and Gas

DEC 13 2018

WV Department of
Environmental Protection

Vertical Section:

After the rig moves on the pad and starts drilling, gyro surveys are taken several times from surface to KOP. After each gyro is taken, the surveys are analyzed by both EQT engineers and the directional drilling well planning technicians and anti-collision is run to ensure current well path is not in the direction of a producing well(s). All of these steps are completed prior to the resumption of drilling. Actual frequency of gyros is determined by engineers and the position of the hole as it relates to existing wells on the pad. No nudges are planned.

- Anti-Collision is a software program into which gyro surveys or MWD/EM surveys are uploaded. The software runs 2-D and 3-D well paths of all wells within the vicinity of the well being drilled.
- While vertically drilling the well, anti-collision software is constantly updated and separation factors (SF) are analyzed.
- Each gyro is analyzed and certified accurate by the gyro company before it is used for any directional planning or modeling. Each tool is roll tested on location and if all surveys are within tolerances the gyro survey is sent to the gyro company's office to be further analyzed and certified accurate.

Horizontal Section:

Directional BHAs are run in the hole and used to drill the well from vertical to horizontal. Gyros or MWD/EM surveys are taken as needed to steer the well until the well is away from the other wells and the risk of collision is eliminated. Surveys utilizing MWD/EM tools are taken continuously until the total depth of the well is achieved. After each survey is taken, the surveys are analyzed by both EQT engineers and the directional drilling well planning technicians and anti-collision is run to ensure current well path is not in the direction of a producing well(s) and consistent with the permitted well path.

- Anti-Collision is a software program into which gyro surveys or MWD/EM surveys are uploaded. The software runs 2-D and 3-D well paths of all wells within the vicinity of the well being drilled.
- Surveys are taken every 100'.
- While directionally drilling the well, anti-collision software is constantly updated and separation factors (SF) are analyzed.
- Each survey is analyzed and certified accurate by the directional company before it is used for any directional planning or modeling.



Where energy meets innovation.

EQT PRODUCTION

02/08/2019



Azimuths to Grid North
True North: 0.68°
Magnetic North: -8.07°

Magnetic Field
Strength: 52016.3nT
Dip Angle: 66.76°
Date: 11/1/2017
Model: IGRF2015

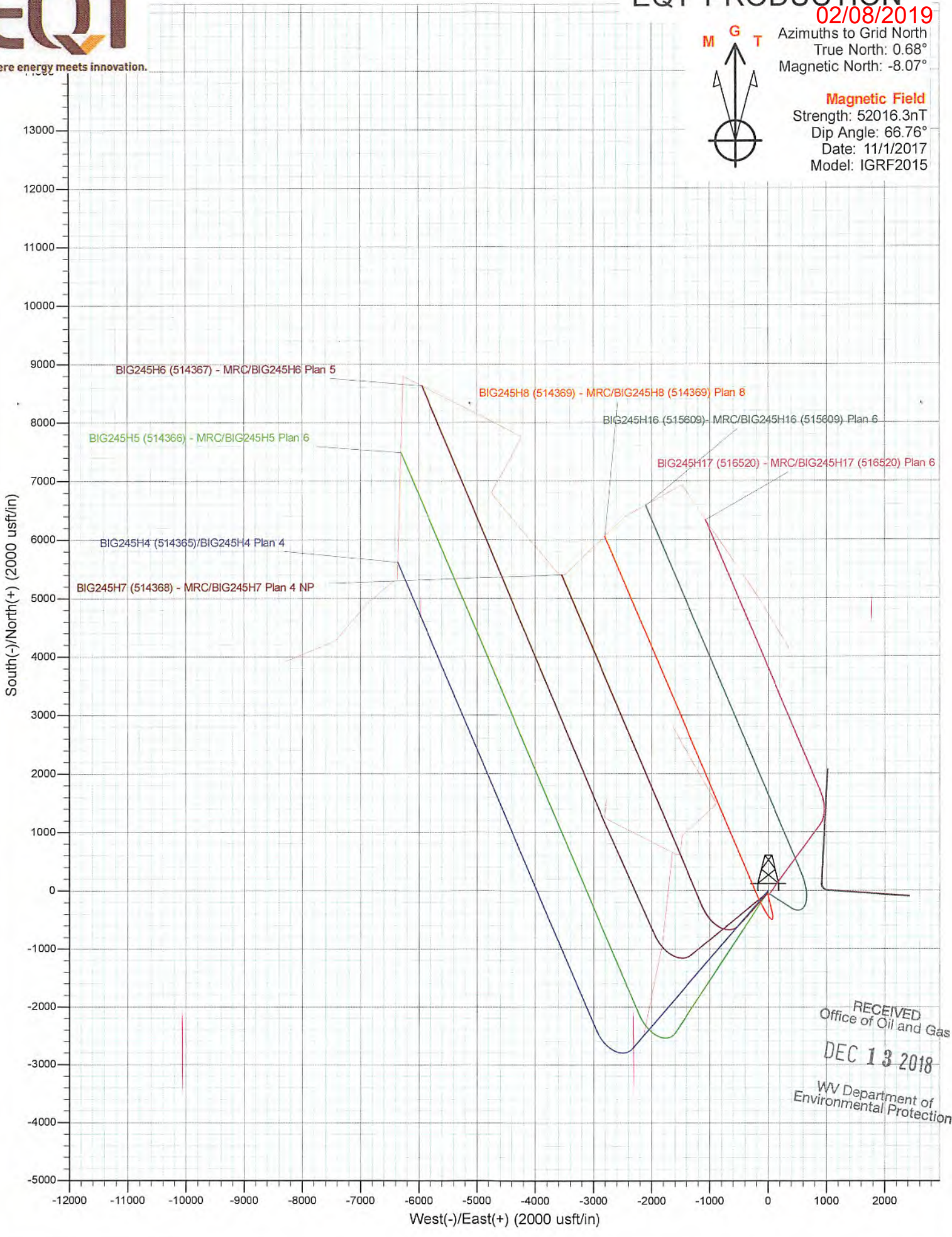

RECEIVED
Office of Oil and Gas
DEC 13 2018
WV Department of
Environmental Protection

Section IX: Deep Well Additional Requirements (IF APPLICABLE)

Formations

See the attached WV Geological Prognosis on the following pages for each well listed on the permit cover page which lists anticipated freshwater, saltwater, oil and gas, hydrogen sulfide, thief zones, high pressure and volume zones and their expected depths

Casing and Cementing

SEE ATTACHED DOCUMENTS FOR EACH WELL

Casing and Cementing notes:

1. All cement volumes are typical, actual conditions may dictate changes in geometry.
2. All casing and cement meet API standards, but are not API monogrammed.
3. Mine strings will be run as required by geologic conditions.
4. Full BOP pressure tests on installation, function test daily, blind ram test on trips.

Flaring Activities

See also Section VII: Flaring for additional information and details.

RECEIVED
Office of Oil and Gas

DEC 13 2018

WV Department of
Environmental Protection

Well **BIG245H8**
EQT Production
Big Run Quad
Wetzel County, WV

ENERTIA # 514369
 Azimuth 337
 Vertical Section 6724

Note: Diagram is not to scale

Formations	Top TVD	Base TVD
Conductor	40	
Base Red Rock	967	
Base Fresh Water	1011	
Surface Casing	1179	
Maxton	2305	2346
Big Lime	2359	2429
Big Injun	2429	2596
Intermediate Casing	2855	
Gordon	3163	3202
Forth Sand	3221	3265
Bayard	3269	3499
Speechley	3891	4113
Riley	4684	4916
Benson	5380	5528
Alexander	5842	6158
Sonyea	7063	7140
Middlesex	7140	7324
Genesee	7324	7362
Geneseo	7362	7388
Tully	7388	7410
Hamilton	7410	7509
Marcellus	7509	7560
Production Casing	14569	MD
Onondaga	7560	

Casing and Cementing				Deepest Fresh Water: 1,011'
Type	Conductor	Surface	Intermediate	Production
Hole Size, In.	30	17 1/2	12 3/8	8 1/2
Casing Size, OD In.	26	13 3/8	9 5/8	5 1/2
Casing Wall Thickness, In.	0.312	0.380	0.395	0.361
Depth, MD	40'	1,179'	2,855'	14,569'
Weight	85.6#	54.5#	40#	20#
Grade	A-500	J-55	A-500	P-110
New or Used	New	New	New	New
Burst (psi)	1378	2,700	3,950	12,640
Cement Class	A	A / Type 1	H	H
Cement Yield	1.18	1.19	1.07	1.123/2.098
Top of Cement (Planned)	Surface	Surface	Surface	500' above top Producing Zone
Method	Displacement	Displacement	Displacement	Displacement
Est. Volume (cu ft)	49	1,086	1,108	1,769
Possible Additives	N/A	Calcium Chloride	Calcium Chloride, Fluid Loss, Defoamer, Dispersant, POZ, Bonding Agent, Extender, Retarder, Flake/LCM	Calcium Carbonate, Fluid Loss, Extender, Dispersant, Viscosifier, Defoamer, POZ, Bonding Agent, Retarder, Anti-Settling/Suspension Agent

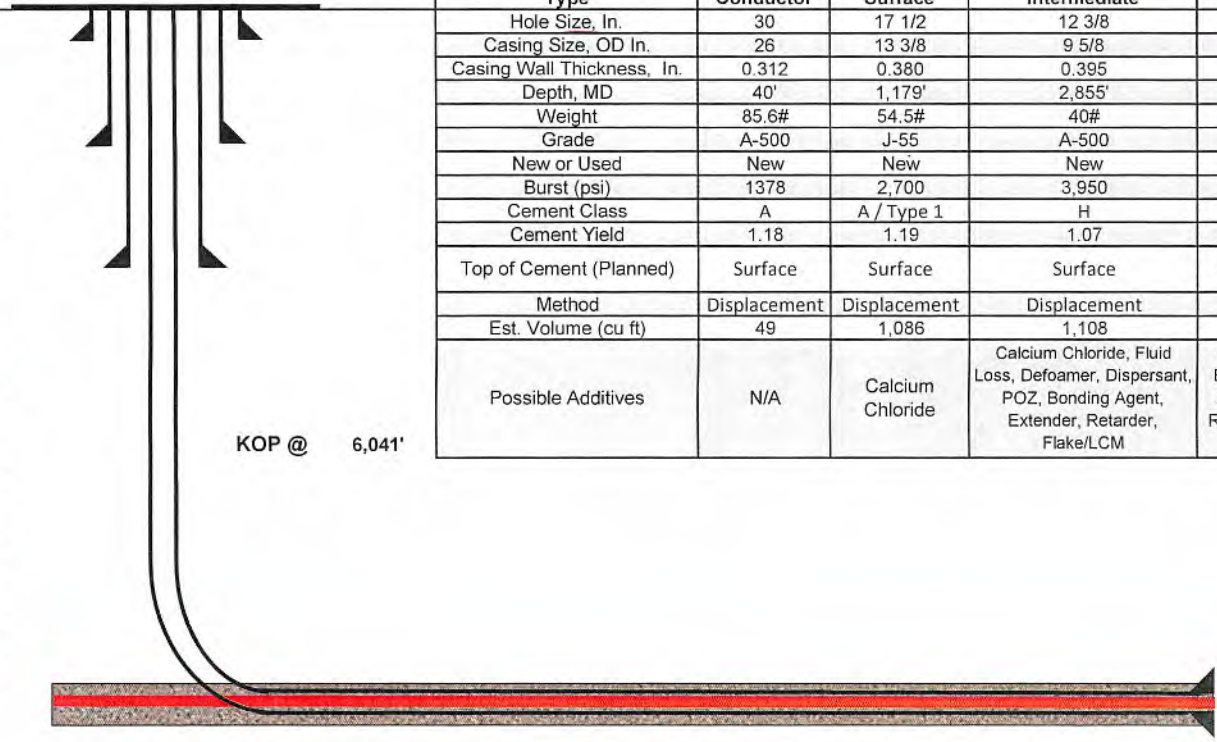

Land curve @ 7,531' TVD 7,992' MD Est. TD @ 7,531' TVD 14,569' MD

Proposed Well Work:
 Drill and complete a new horizontal well in the Marcellus formation.
 Drill the vertical to an approximate depth of 6041'.
 Kick off and drill curve. Drill lateral in the Marcellus. Cement casing.

6,577' Lateral

WEST VIRGINIA GEOLOGICAL PROGNOSIS

Horizontal Well
BIG245H8

Enerzia # 514369

Drilling Objectives: Marcellus
County: Wetzel
Quad: Big Run
Elevation: 1429 KB 1416 GL

Well: 514369(BIG245H8)
Surface location Northing: 400676.66 Easting: 1698751.08
Landing Point Northing: 400741.06 Easting: 1698533.00
Toe location Northing: 406795.66 Easting: 1695962.97
Recommended Azimuth 337 Degrees LP TVD: 7531
 Recommended LP to TD: 6,577'

Proposed Logging Suite: N/A
 Geologist to recommend when Mudloggers need to be on location to run samples and measure gas thru both the curve and lateral sections.

Recommended Gas Tests: 1800, 2050, 2600, Intrn Csg Pt., 3400, 4900, 5250, KOP, (Gas test at any mine void)
 Gas test during any trip or significant downtime while drilling the lateral section.

ESTIMATED FORMATION TOPS

Formation	Top (TVD)	Base (TVD)	Lithology	Comments
Fresh Water Zone	1	1011		FW @ 229,507,662,752,1011,
Waynesburg Coal	925	926	Coal	
Mapletown Coal	1024	1033	Coal	
Pittsburgh Coal	1123	1129	Coal	There are no known past, present, or future mining and/or permits
STORAGE ZONE	2369	2425	Sandstone	STORAGE ZONE
Maxton	2305	2346	Sandstone	Base of Offset Well Perforations at 1157' TVD
Big Lime	2359	2429	Limestone	
Big Injun	2429	2596	Sandstone	
Weir	2765	2805	Silty Sand	
Int csg pt	2855			
Top Devonian	2981			
Gordon	3163	3202	Silty Sand	
Forth Sand	3221	3265	Silty Sand	
Bayard	3269	3499	Silty Sand	
Speechley	3891	4113	Silty Sand	
Riley	4684	4916	Silty Sand	
Benson	5380	5528	Silty Sand	
Alexander	5842	6158	Silty Sand	
Elks	6158	7063	Gray Shales and Silts	
Sonyea	7063	7140	Gray shale	
Middlesex	7140	7324	Shale	
Genesee	7324	7362	Gray shale interbedded	
Genesee	7362	7388	Black Shale	
Tully	7388	7410	Limestone	
Hamilton	7410	7509	Gray shale with some	
Marcellus	7509	7560	Black Shale	
Purcell	7521	7524	Limestone	
Lateral Zone		7531		
Cherry Valley	7541	7545	Limestone	
Onondaga	7560		Limestone	

Top RR	Base RR
211	224
259	271
274	284
306	324
367	377
477	489
549	569
806	815
811	817
844	851
962	967

Base of Red Rock

Target Thickness	51 feet
Max Anticipated Rock Pressure	2620 PSI

Comments:
 Note that this is a TVD prog for a horizontal well (azimuth of 337 degrees; target formation = Marcellus). All measurements taken from estimated KB elevation. Water and coal information estimated from surrounding well data.
 Intermediate casing point is recommended 50' beneath the Weir to shut off any water production from the Upper Devonian sands. Keener storage zone from 2369' to 2425' MD, please take all necessary precautions while drilling!! Intermediate casing should be cemented into the surface string, per WV regulations.
 The estimated landing point TVD is 7531', rig geologist may adjust landing point. After the well is landed, drill to reported bed dips/ geologists' recommendation. The geologic structure is unknown at this time.

LATERAL DRILLING TOLERANCES

Mapview - Lateral: Deviate as little as possible to the left or right of the planned wellbore
Mapview - TD: DO NOT EXTEND beyond recommended wellbore to avoid lease line.

RECOMMENDED CASING POINTS

	CSG OD		CSG DEPTH:		
Fresh Water/Coal	13 3/8		1179		50' below Pittsburgh
Intermediate 1:	9 5/8		2855		50' below Weir
Production:	5 1/2		@ TD		

RECEIVED
 Office of Oil and Gas
 DEC 13 2018
 WV Department of
 Environmental Protection



Where energy meets innovation.™

WELL SITE SAFETY PLAN RECEIPT ACKNOWLEDGMENT

This form letter is to be signed by the LEPC or CES representative to indicate they have received the Site Safety Plan for the following well site location and understand its use.

Site Location:

WV- Wetzel County – Burton
Site State, County and Municipality

EQT BIG245 Pad
Site Location Designation

1510 Anderson Run Rd. Burton, WV 26562
Site Address assigned by County 9-1-1

Wiley Fork Road
Nearest cross road(s)

39.593922, -80.569740
Access Road Coordinates

39.595333, -80.568706
Pad Site Coordinates

I have received my copy of the *Well Site Safety Plan* for the above described location. I understand that this is a reference tool for emergency response and it is my responsibility to read and understand the Plan.

LCEP or CES Representative (printed)

EQT Representative (printed)

Representative Affiliation and Title

EQT Representative Title

Representative Signature

EQT Representative Signature

Date

Date

RECEIVED
Office of Oil and Gas
DEC 13 2018
WV Department of
Environmental Protection

WW-6A1
(5/13)

Operator's Well No. BIG245H8

**INFORMATION SUPPLIED UNDER WEST VIRGINIA CODE
Chapter 22, Article 6A, Section 5(a)(5)
IN LIEU OF FILING LEASE(S) AND OTHER CONTINUING CONTRACT(S)**

Under the oath required to make the verification on page 1 of this Notice and Application, I depose and say that I am the person who signed the Notice and Application for the Applicant, and that –

- (1) the tract of land is the same tract described in this Application, partly or wholly depicted in the accompanying plat, and described in the Construction and Reclamation Plan;
- (2) the parties and recordation data (if recorded) for lease(s) or other continuing contract(s) by which the Applicant claims the right to extract, produce or market the oil or gas are as follows:

Lease Name or Number	Grantor, Lessor, etc.	Grantee, Lessee, etc.	Royalty	Book/Page
See Attached				

**Acknowledgement of Possible Permitting/Approval
In Addition to the Office of Oil and Gas**

The permit applicant for the proposed well work addressed in this application hereby acknowledges the possibility of the need for permits and/or approvals from local, state, or federal entities in addition to the DEP, Office of Oil and Gas, including but not limited to the following:

- WV Division of Water and Waste Management
- WV Division of Natural Resources WV Division of Highways
- U.S. Army Corps of Engineers
- U.S. Fish and Wildlife Service
- County Floodplain Coordinator

The applicant further acknowledges that any Office of Oil and Gas permit in no way overrides, replaces, or nullifies the need for other permits/approvals that may be necessary and further affirms that all needed permits/approvals should be acquired from the appropriate authority before the affected activity is initiated.

Well Operator: EQT Production Company

By: Erin Spine

Its: Regional Land Supervisor

RECEIVED
Office of Oil and Gas
DEC 13 2018

WW-6A1 attachment

Operator's Well No.

BIG245H8

<u>Lease No.</u>	<u>Grantor, Lessor, etc.</u>	<u>Grantee, Lessee, etc.</u>	<u>Royalty</u>	<u>Book/Page</u>
<u>125397</u>	<u>Shiben Estates, Inc., et al. (Current Royalty Owner)</u> Joseph Shiben, et al. (Original Lease) Equitable Gas Company Equitrans, Inc. Equitrans, LP	Equitable Gas Company Equitrans, Inc. Equitrans, LP EQT Production Company	**	DB 44A/224 O&G 71A/453 DB 105/908 O&G 131A/81
<u>102836</u>	<u>Shiben Estates, Inc., et al (Current Royalty Owner)</u> S I Robinson The Philadelphia Company Pittsburgh and West Virginia Gas Co. Equitable Gas Company Equitrans, Inc. Equitrans, LP	The Philadelphia Company Pittsburgh and West Virginia Gas Co. Equitable Gas Company Equitrans, Inc. Equitrans, LP EQT Production Company	**	DB 47/469 DB 146/98 DB 187/374 OG 71A/453 DB 105/908 OG 131A/81
<u>102814</u>	Joseph Shiben and Minnie Shiben Estate, et al.	EQT Production Company	**	DB 182A/84

** Per West Virginia Code Section 22-6-8.

RECEIVED
Office of Oil and Gas
DEC 13 2018
WV Department of
Environmental Protection

EQT Production
Hydraulic Fracturing Monitoring Plan

Pad ID: BIG245

County: Wetzel

11/29/2018

RECEIVED
Office of Oil and Gas
DEC 13 2018
WV Department of
Environmental Protection

Purpose

The purpose of this pad-specific Hydraulic Fracturing Monitoring Plan is to identify and notify conventional well operators near EQT hydraulic fracturing in **Wetzel County**, WV prior to hydraulic fracturing at the following EQT wells on **BIG245H4, BIG245H5, BIG245H6, BIG245H8, BIG245H16, and BIG245H17**.

Due to the requirements under 35CSR8 5.11, the permittee is required to review the area surrounding the proposed well pad so as to identify and evaluate potential conduits for unintended fracture propagation.

A report is required to be submitted along with a well work permit application.

The plan is being implemented as an additional safety measure to be utilized in conjunction with existing best management practices and emergency action plans for the site. These additional measures include coordination with well operators of the timing and location of the hydraulic fracturing, establishment of measures well operators should implement, and assurance that the OOG is notified of the timeline, as well as any issues that may arise during fracturing.

1. Communications with Well Operators

EQT, using available data (WV Geological Survey, WVDEP website, and IHS data service), has identified all known wells and well operators within 500 feet of this pad and the lateral sections that are known or could reasonably be expected to be within range of the fracture propagation. A map showing these wells along with a list of the wells and operators is included in **Attachment A**.

EQT will notify these operators of the hydraulic fracturing schedule for these wells, and coordinate with them throughout the fracturing process.

EQT will recommend to these operators at a minimum to:

1. Inspect their surface equipment prior to fracturing to establish integrity and establish pre-frac well conditions
2. Observe wells closely during and after fracturing and monitor for abnormal increases in water, gas or pressure
3. Inspect or install master valves or other necessary equipment for wellhead integrity capable of a pressure recommended by EQT
4. Notify the OOG and EQT if any changes in water, gas production, pressure, or other anomalies are identified

2. Reporting

EQT will provide information relating to the hydraulic fracturing schedule, communication with other operators, and ongoing monitoring of the work upon request of OOG or immediately in the event of any noted abnormalities.

API Number	Abandoned Date	Completion Date	Current Operator	Elevation	Elevation Reference	Final Status	Lat	Long	Well Name	Permit Date	SPUD Date	TD Formation	Total Depth	Permit
4710300331		11/17/1903	PGH & WV GAS	1109	GR	GAS	39.5883	-80.568					2285	00331
4710300640000	5/21/1934	3/1/1932	PITTSBURGH & W VA GAS	1505	GR	ABD-GW	39.6022	-80.5863	5403 J P ASHCRAFT	1/16/1932	1/31/1932	FOURTH SAND	3634	00064
47103002830001		7/13/1944	STANDARD OIL COMPANY INCORPORATED	1515	GR	GAS	39.6093	-80.5833	1374 H L & IUTT E	5/29/1944	6/13/1944	GORDON	3289	00283
47103003710000		2/1/1951	J C R PETROLEUM INCORPORATED	825	GR	GAS-CB	39.5887	-80.5756	15 B HIGGINBOTHAM ET AL	12/18/1950	1/2/1951	CONEMAUGH /SERIES/	530	00371
47103003720000	8/7/1963	3/1/1951	UNKNOWN	842	GR	ABD-CB	39.5897	-80.5788		1/15/1951	1/30/1951	PITTSBURGH COAL	523	00372
47103003760000		4/1/1952	J C R PETROLEUM INCORPORATED	1265	GR	GAS-CB	39.5924	-80.5721	25 J ROBINSON ET AL	2/16/1952	3/2/1952	CONEMAUGH /SERIES/	1008	00376
47103003800000	7/6/1952	5/1/1952	UNKNOWN	1267	GR	D&A-OG	39.5937	-80.5730		3/17/1952	4/1/1952	CONEMAUGH /SERIES/	1185	00380
47103003810000		6/24/1952	J C R PETROLEUM INCORPORATED	818	GR	GAS-CB	39.5841	-80.5776	15 B HIGGINBOTHAM	5/10/1952	5/25/1952	PITTSBURGH COAL	515	00381
47103003830000		4/10/1953	J C R PETROLEUM INCORPORATED	960	GR	GAS-CB	39.6045	-80.5773	1 J C ASHCRAFT	10/6/1952	10/21/1952	CONEMAUGH /SERIES/	686	00383
47103003840000		5/1/1953	J C R PETROLEUM INCORPORATED	855	GR	GAS-CB	39.6008	-80.5724	2 J P ASHCRAFT	3/17/1953	4/1/1953	CONEMAUGH /SERIES/	585	00384
47103003850000		8/1/1953	J C R PETROLEUM INCORPORATED	905	GR	GAS-CB	39.6021	-80.5734	3 J P ASHCRAFT	6/17/1953	7/2/1953	CONEMAUGH /SERIES/	647	00385
47103003860000		6/1/1953	EQT PRODUCTION COMPANY	847	GR	GAS-CB	39.5986	-80.5752	1 H L SMITH	4/17/1953	5/2/1953	CONEMAUGH /SERIES/	570	00386
47103004320000	7/18/1956	6/1/1956	UNKNOWN	994	GR	D&A	39.6102	-80.5730		4/17/1956	5/2/1956	TIONESTA /SD/	1495	00432
47103004330000		8/1/1956	J C R PETROLEUM INCORPORATED	1509	GR	GAS-CB	39.6066	-80.5830	7 J P ASHCRAFT	6/17/1956	7/2/1956	CONEMAUGH /SERIES/	1235	00433
47103004490000		6/15/1957	NORTH FORK DEVELOPMENT	827	GR	GAS-CB	39.5812	-80.5650		5/18/1957	6/2/1957	PENNSYLVANIAN	537	00449
47103004510000	1/1/1965	7/1/1957	NORTH FORK DEVELOPMENT	817	GR	ABD-CB	39.5829	-80.5665	2 J HERBERT HIGGINBOTHAM	5/17/1957	6/1/1957	PENNSYLVANIAN	529	00451
47103004520000		8/1/1957	NORTH FORK DEVELOPMENT	886	GR	GAS-CB	39.5841	-80.5635	3 J HERBERT HIGGINBOTHAM	6/17/1957	7/2/1957	PITTSBURGH COAL	614	00452
47103004530000	11/16/1957	10/1/1957	UNKNOWN	979	GR	D&A	39.5823	-80.5622		8/17/1957	9/1/1957	PENNSYLVANIAN	725	00453
47103004570000	2/14/1958	1/1/1958	UNKNOWN	1108	GR	D&A-G	39.5842	-80.5661		11/17/1957	12/2/1957	AMES /LM/	859	00457
47103004930000	10/4/1953	12/30/1915	EQUITABLE GAS COMPANY	1163	GR	ABD-GW	39.5889	-80.5743	5131 5 I ROBINSON 2	10/31/1915	11/15/1915	BIG INJUN /SD/	2234	00493
47103004940000			EQUITABLE GAS COMPANY	1086	GR	GSTG	39.5863	-80.5734	5431 D KOHN	1/1/1801	1/1/1801	CHEMUNG	2088	00494
47103004950001	11/19/1952	6/19/1946	PITTSBURGH & W VA GAS	1109	GR	D&A-G	39.5884	-80.5679	1768 J M SNIDER 1	5/5/1946	5/20/1946	BIG INJUN /SD/	2285	00495
47103004960000	1/1/1935	8/4/1902	PITTSBURGH & W VA GAS	844	GR	ABD-GW	39.5864	-80.5672	1737 5 I ROBINSON	6/5/1902	6/20/1902	HAMPSHIRE	2785	00496
47103004990000			EQUITABLE GAS COMPANY	923	GR	GSTG	39.5829	-80.5693	5434 SOLE	1/1/1801	1/1/1801	CHEMUNG	2712	00499
47103005090000	6/19/1948	8/4/1919	DUNN-MAR OIL & GAS COMPANY	1155	GR	ABD-GW	39.5860	-80.5608	5398 ISAAC HIGGINBOTHAM 1	12/8/1918	12/23/1918	CHEMUNG	3243	00509
47103005100000		8/1/1961	PEMCO GAS INCORPORATED	934	GR	GAS-CB	39.6009	-80.5784	2 H L SMITH	6/17/1961	7/2/1961	CONEMAUGH /SERIES/	662	00510
47103005140000		5/1/1962	J A & M OIL & GAS	1107	GR	GSTG	39.5926	-80.5617	5447 C A LONG	3/17/1962	4/1/1962	BIG INJUN /SD/	00514	
47103005160000			J A & M OIL & GAS	1034	GR	UNKWN	39.5809	-80.5703	5448 L B SMITH 1	1/1/1801	1/1/1801	BIG INJUN /SD/	2090	00516
47103005170000		6/1/1962	EQUITABLE GAS COMPANY	869	GR	GSTG	39.5977	-80.5753	5449 M D SMITH	4/17/1962	5/2/1962	BIG INJUN /SD/	00517	
47103005200000	1/1/1964	8/2/1919	HOPE NATURAL GAS	937	GR	ABD-GW	39.5794	-80.5571	5532 J M BROWN	6/18/1919	7/3/1919	BIG INJUN /SD/	2025	00520
47103005220000			UNKNOWN	1214	GR	UNKWN	39.5876	-80.5569	5441 FRANCES SHREVE	1/1/1801	1/1/1801	CHEMUNG	3154	00522
47103005230000		1/1/1963	EQUITABLE GAS COMPANY	846	GR	GSTG	39.5810	-80.5569	5451 F SHREVE	11/17/1962	12/2/1962	BIG INJUN /SD/	00523	
47103005240000		4/5/1919	EQUITABLE GAS COMPANY	972	GR	GAS	39.5848	-80.5569	5296 SILAS SHREVE 1	1/7/1919	1/22/1919	CHEMUNG	2882	00524
47103005310000	1/1/1962		EQUITABLE GAS COMPANY	1098	GR	PSEUDO	39.5771	-80.5540	5440 C E BROWN ETAL 1				00531	
47103005330000	1/1/1962	12/11/1902	PITTSBURGH & W VA GAS	829	GR	ABD-GW	39.5841	-80.5685	1751 JOHN E SNYDER	10/12/1902	10/27/1902	POCONO	1928	00533
47103005340000			EQUITABLE GAS COMPANY	1067	GR	GSTG	39.5826	-80.5590	5443 SOLE	1/1/1801	1/1/1801	CHEMUNG	2880	00534
47103005380000			EQUITABLE GAS COMPANY	836	GR	UNKWN	39.5794	-80.5635	5454 ELVA R KING	1/1/1801	1/1/1801	BIG INJUN /SD/	1850	00538
47103005660000		1/1/1965	J C R PETROLEUM INCORPORATED	880	GR	GAS-CB	39.5896	-80.5764	3 S B HIGGINBOTHAM HRS	11/17/1964	12/2/1964	CONEMAUGH /SERIES/	548	00566
47103008450000	11/7/1990	9/22/1905	PITTSBURGH & W VA GAS	1290	GR	ABD-GW	39.6099	-80.5860	1847 J P ASHCRAFT	7/5/1905	7/20/1905		3112	00845
47103008610000	6/29/1990		EQUITABLE GAS COMPANY	1000	GR	UNKWN	39.6000	-80.5882	5198 ASHCRAFT	1/1/1801	1/1/1801	UNKNOWN	3500	00861
47103008840001		11/7/1989	EQUITRANS INCORPORATED	1167	GR	D&A	39.5922	-80.5683	5426 D/R LUMBER CO	10/17/1989	11/1/1989	GREENBRIER /LM/	2211	00884
47103011450000			MEADOW RIDGE DEVELOPMENT LLC		GR	PSEUDO	39.5830	-80.5582	122 MILLS				01145	
47103306460000	1/1/1948	3/19/1915	DUNN-MAR OIL & GAS COMPANY	1197	GR	ABD-GW	39.5772	-80.5682	3725 F L HIGGINBOTHAM	1/10/1915	1/25/1915	HAMPSHIRE	3339	30646
47103311450000	1/1/1962		EQUITABLE GAS COMPANY	0	GR	PSEUDO	39.5826	-80.5586	5443 ADDA M SOLE 1				31145	
47103702670000			HOPE NATURAL GAS		GR	PSEUDO	39.5890	-80.5570	4983 SILAS SHREVE				70267	
47103704190000			HOPE NATURAL GAS		GR	PSEUDO	39.5905	-80.5776	15 B HIGGINBOTHAM				70419	
47103704200000			PHILADELPHIA OIL		GR	PSEUDO	39.6022	-80.5701	1 J P ASHCRAFT ET AL				70420	
47103704220000			HOPE NATURAL GAS		GR	PSEUDO	39.5799	-80.5619	1 L HIGGINBOTHAM				70422	
47103704230000			PHILADELPHIA OIL		GR	PSEUDO	39.5838	-80.5670	1 ISRAEL SNYDER				70423	
47103719390000			UNKNOWN		GR	UNKWN	39.5913	-80.5763	1 S B HIGGINBOTHAM				71939	
47103719410000			PHILADELPHIA OIL		GR	UNKWN	39.6041	-80.5731	385 J F UTT				71941	
47103719430000			UNKNOWN		GR	UNKWN	39.5923	-80.5814	2 J B HICKS				71943	
47103719470000			UNKNOWN		GR	UNKWN	39.5957	-80.5825	1 JAMES SHIRLEY				71947	
47103719480000			UNKNOWN		GR	UNKWN	39.5963	-80.5818	1 JAMES SHIRLEY				71948	
47103719490000			UNKNOWN		GR	UNKWN	39.5983	-80.5812	5933 JOLLY MINOR				71949	
47103719500000			PEMCO GAS INCORPORATED		GR	UNKWN	39.6031	-80.5795	5247 M & J SHIVEN HEIRS 10				71950	
47103719570000			UNKNOWN		GR	UNKWN	39.6118	-80.5916	1787 OLLIE SIX 1				71957	
47103719580000			UNKNOWN		GR	UNKWN	39.6140	-80.5903	5304 OLLIE SIX				71958	
47103719590000			UNKNOWN		GR	UNKWN	39.6125	-80.5893	1 OLLIE SIX				71959	
47103719600000			UNKNOWN		GR	UNKWN	39.6122	-80.5875	1 OLLIE SIX				71960	
47103719620000			UNKNOWN		GR	UNKWN	39.6108	-80.5839	1736 THOMAS UTT				71962	
47103720330000			UNKNOWN		GR	UNKWN	39.5829	-80.5759	1 C BROOKOVER				72033	
47103720340000			CARNEGIE NATURAL GAS CORPORATION		GR	UNKWN	39.5822	-80.5758	747 C BROOKOVER 1				72034	
47103720350000			UNKNOWN		GR	UNKWN	39.5781	-80.5754	5307 JAMES JOHNSON 1				72035	
47103720380000			PHILADELPHIA OIL		GR	UNKWN	39.5714	-80.5724	5287 CHARLES BREWER				72038	
47103720390000			UNKNOWN		GR	UNKWN	39.5719	-80.5701	1 R BARR				72039	
47103720670000			EQUITRANS INCORPORATED		GR	UNKWN	39.6083	-80.5888	1770 M & J SHIBEN HEIRS				72067	
47103722830000			HOPE NATURAL GAS		GR	UNKWN	39.5767	-80.5640	852 F L HIGGINBOTHAM				72283	

RECEIVED
 Office of Oil and Gas
 DEC 13 2018
 WV Department of
 Environmental Protection

02/08/2019

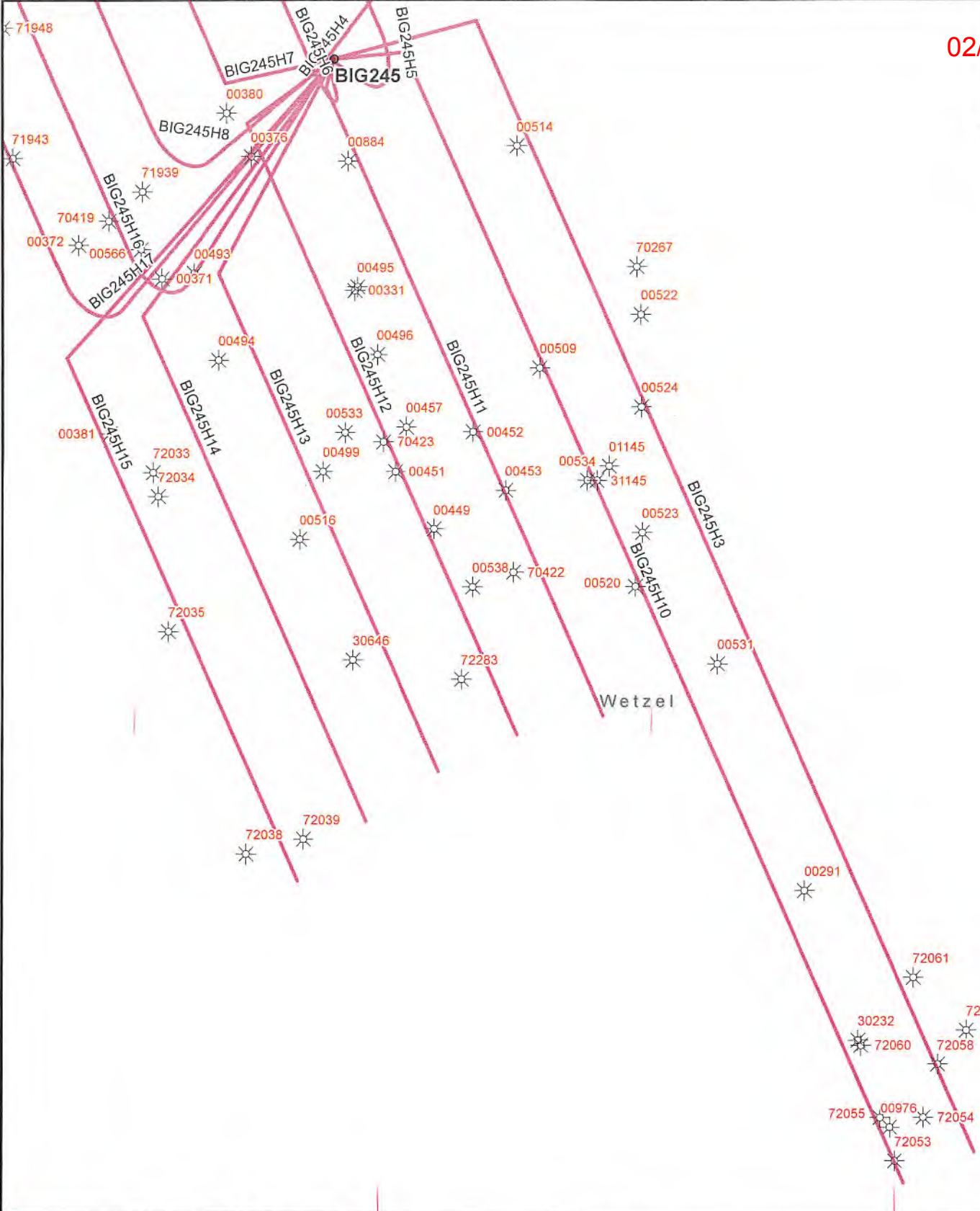

EQT
EQT Corporation
625 Liberty Avenue
Pittsburgh, PA 15222

Big 245 - South

Vertical Offsets and
Foreign Laterals
within 500'

- SPUDS**
- GO
 - MD
 - MR
 - PT
 - Planned Marcellus

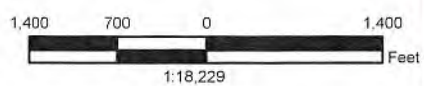

Disclaimer:

This map is confidential and is to be used only for the express informational purposes for which it was created. Unauthorized use, copying, or dissemination is strictly prohibited. EQT does not warrant the accuracy of the location of any items shown on this map, including, but not limited to, any structures, well or pipeline facilities, property boundaries, topography, roadways, or waterways. The items shown on the map may not have been placed on the map using survey lines or GPS coordinates. The specific location of any of the map items should be determined by a field survey performed by a licensed surveyor upon consultation with EQT.



02/08/2019

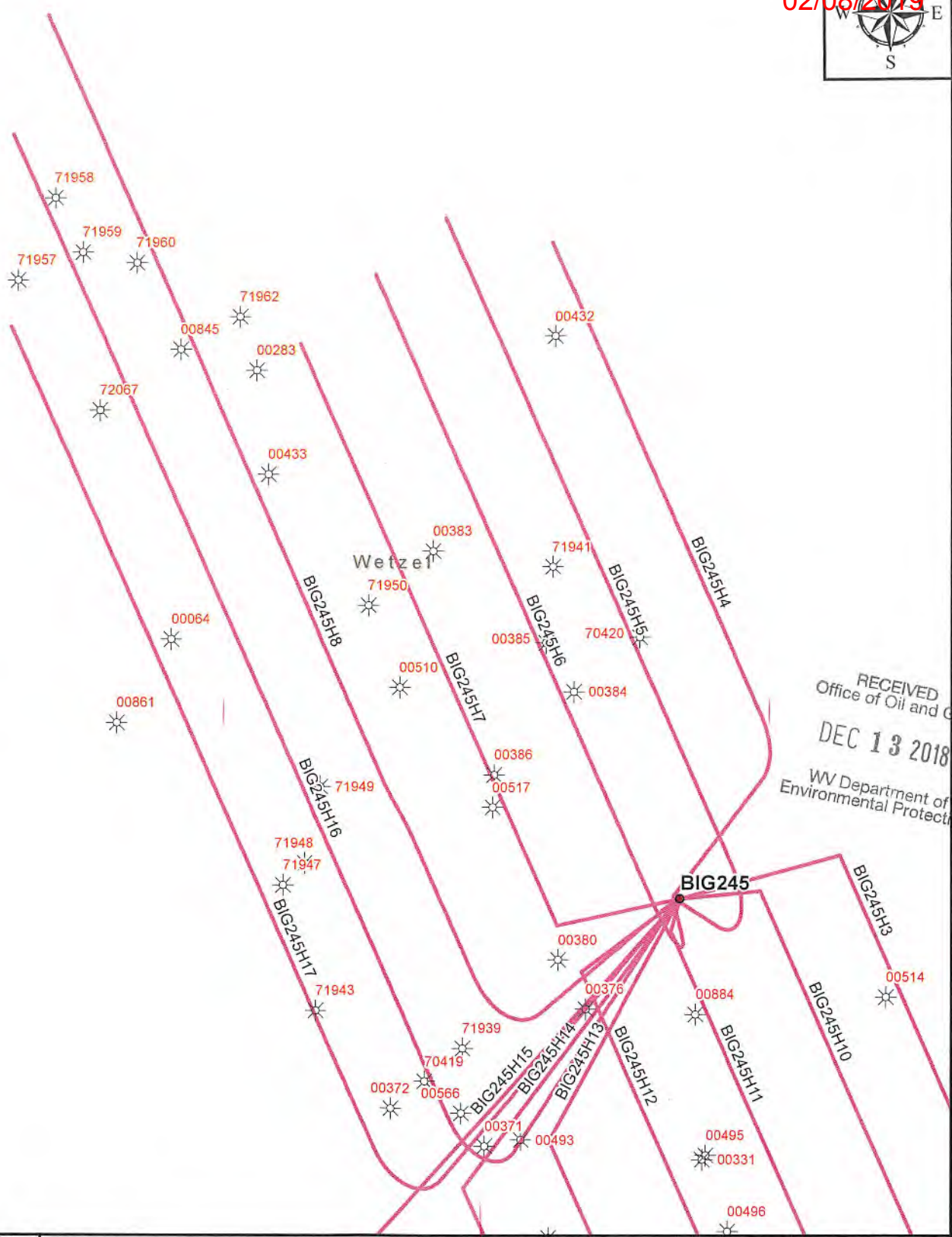

RECEIVED
Office of Oil and Gas
DEC 13 2018
WV Department of
Environmental Protection

EQT
EQT Corporation
625 Liberty Avenue
Pittsburgh, PA 15222

Big 245 - North

Vertical Offsets and
Foreign Laterals
within 500'

- SPUDS**
- GO
 - MD
 - MR
 - PT
 - Planned Marcellus

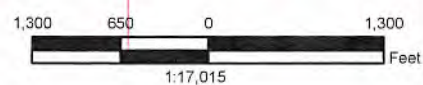

Disclaimer:

This map is confidential and is to be used only for the express informational purposes for which it was created. Unauthorized use, copying, or dissemination is strictly prohibited. EQT does not warrant the accuracy of the location of any items shown on this map, including, but not limited to, any structures, well or pipeline facilities, property boundaries, topography, roadways, or waterways. The items shown on the map may not have been placed on the map using survey lines or GPS coordinates. The specific location of any of the map items should be determined by a field survey performed by a licensed surveyor upon consultation with EQT.

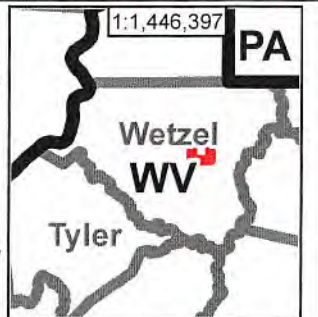

**BIG245
BIG245H8
EQT PRODUCTION COMPANY**

BOTTOM HOLE LATITUDE 39°37'30"

10,572'

TAG	TM-PAR.	SURFACE OWNERS	ACRES
A	G-TM-3-2	JOSEPH F & GAY BLAKE IRREVOCABLE GRANTOR TR.	194 AC.
B	G-TM-3-5	COASTAL FOREST RESOURCES CO	179 AC.
C	G-TM-3-14	CHARLES STONEKING ET AL.	70.50 AC.
D	G-TM-3-15	CHARLES STONEKING ET AL.	45 AC.
E	G-TM-3-16	CHARLES STONEKING ET AL.	14.11 AC.
F	G-TM-3-18	VIRGINIA RUTH BLAKE	28.75 AC.
G	G-TM-3-19	JOSEPH R PERHAC	93.50 AC.
H	G-TM-3-23	COASTAL FOREST RESOURCES CO	167.75 AC.
I	G-TM-3-24	COASTAL FOREST RESOURCES CO	35.89 AC.
J	G-TM-3-25	CHARLES STONEKING ET AL.	34.4 AC.
K	G-TM-3-26	VIRGINIA RUTH BLAKE	20.69 AC.
L	G-TM-3-27	VIRGINIA RUTH BLAKE	45.83 AC.
M	G-TM-3-30	THOMAS E & CHERYL A LEASURE	51.80 AC.
N	G-TM-3-34	MIKE & MADELINE WHITE	30.6 AC.
O	G-TM-8-1	DANNY STOCKSLAGER ET AL	170 AC.
P	G-TM-8-2	MIKE & MADELINE WHITE	40.13 AC.
Q	G-TM-8-3	MIKE & MADELINE WHITE	3 AC.
R	G-TM-8-7	JAMES E & MARTIN A STONEKING	19.12 AC.
S	G-TM-8-8	WANDA L BYARD	59.16 AC.
T	G-TM-8-10	GARLAND E MINOR	48.1 AC.
U	G-TM-8-11	BONNIE M HENTHORNE	63.50 AC.
V	G-TM-8-12	SHIRLEY A TITUS	41.9 AC.
W	G-TM-8-12.1	DALE F SAPP	10.1 AC.
X	G-TM-8-14	NEAL UTT	51 AC.
Y	G-TM-8-15	JOHN MICHAEL BYARD	71.60 AC.
Z	G-TM-8-21	IKEY JOE WILLEY	76.27 AC.
AA	G-TM-8-22	ET BLUEGRASS LLC, C/O EQT PRODUCTION CO	138.93 AC.
BB	G-TM-8-23	DALE K, JAMES L & DONALD J DULANEY	70.81 AC.
CC	G-TM-8-25	JAMES ARTHUR YOHO	6.25 AC.
DD	G-TM-8-27	JAMES ARTHUR YOHO	21.75 AC.
EE	G-TM-8-28	JAMES ARTHUR & FLORENCE YOHO	61 AC.
FF	G-TM-8-4	DUANE M GOODRICH	1.625 AC.
GG	G-TM-8-5	DUANE M GOODRICH	130 SQ RDS
HH	G-TM-8-6	DUANE M GOODRICH	164 SQ RDS
II	G-TM-8-13	NEAL UTT	3.75 AC.
JJ	G-TM-8-13.1	DUANE M GOODRICH	3.56 AC.
KK	G-TM-3-28	JOHN & BONNIE RICE	5 AC.
LL	C-TM-19-14	JOSEPH R PERHAC	88.5 AC.

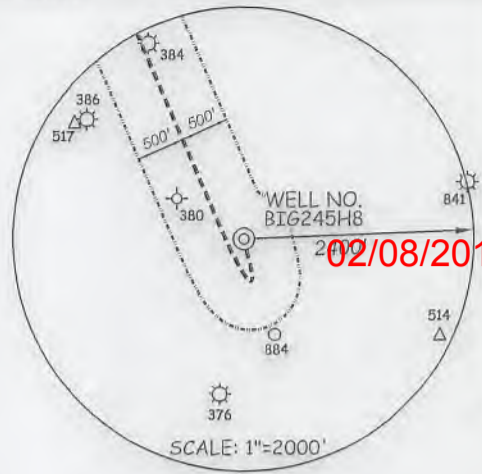

NOTES ON SURVEY

1. NO WATER WELLS WERE FOUND WITHIN 250' OF PROPOSED GAS WELL. NO AGRICULTURAL BUILDINGS 2500 SQ. FT. OR GREATER WERE FOUND WITHIN 625' OF THE CENTER OF PROPOSED WELL PAD.
2. WELL SPOT CIRCLE (SHEET 1) AND TOPO MARK SCALE IS 1" = 2000'.

ROYALTY OWNERS		
SHIBEN ESTATES INC. ET AL.	192 AC.± (160.96)	LEASE NO. 102836
JOSEPH SHIBEN & MINNIE SHIBEN ESTATE ET AL.	1030 AC.±	LEASE NO. 102914

REFERENCES

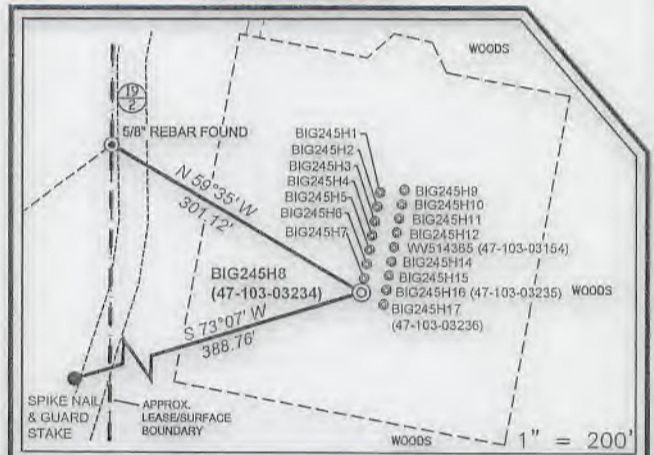

(S.P.C. NORTH ZONE) (UTM(M) ZONE 17 NORTH)

NAD'27 S.P.C. (FT)	N. 400,676.62	E. 1,698,751.10
NAD'27 GEO.	LAT-(N) 39.595169	LONG-(W) 80.569038
NAD'83 UTM (M)	N. 4,382,924.508	E. 537,019.345
LANDING POINT		
NAD'27 S.P.C. (FT)	N. 400,741.06	E. 1,698,533.00
NAD'27 GEO.	LAT-(N) 39.595339	LONG-(W) 80.569914
NAD'83 UTM (M)	N. 4,382,943.030	E. 536,952.572
BOTTOM HOLE		
NAD'27 S.P.C. (FT)	N. 406,795.66	E. 1,695,962.97
NAD'27 GEO.	LAT-(N) 39.611876	LONG-(W) 80.579192
NAD'83 UTM (M)	N. 4,384,774.543	E. 536,138.951



I THE UNDERSIGNED, HEREBY CERTIFY THAT THIS PLAT IS CORRECT TO THE BEST OF MY KNOWLEDGE AND BELIEF AND SHOWS ALL THE INFORMATION REQUIRED BY LAW AND THE REGULATIONS ISSUED AND PRESCRIBED BY THE DIVISION OF ENVIRONMENTAL PROTECTION.

P.S. 849 *C. Victor Moyers*



(+) DENOTES LOCATION OF WELL ON UNITED STATES TOPOGRAPHIC MAPS.

DATE MAY 1, 20 18

REVISED 08/06/18, 11/15/18, 11/30/18

OPERATORS WELL NO. BIG245H8

API WELL NO. 47-103-03234
STATE COUNTY PERMIT

MINIMUM DEGREE OF ACCURACY 1 / 2500 FILE NO. 7812PBIG245H8-R3.dwg
HORIZONTAL & VERTICAL CONTROL DETERMINED BY DGPS (SURVEY GRADE TIE TO CORS NETWORK) SCALE SEE NOTE 2

STATE OF WEST VIRGINIA
DIVISION OF ENVIRONMENTAL PROTECTION
OFFICE OF OIL AND GAS



WELL TYPE: OIL GAS LIQUID INJECTION WASTE DISPOSAL IF "GAS" PRODUCTION STORAGE DEEP SHALLOW

LOCATION: GROUND PROPOSED
ELEVATION 1485' 1430' WATERSHED ROCKCAMP RUN OF WILLEY FORK
DISTRICT GRANT COUNTY WETZEL QUADRANGLE BIG RUN 7.5'

SURFACE OWNER ET BLUE GRASS, LLC ACREAGE 138.93±
ROYALTY OWNER SHIBEN ESTATES, INC ACREAGE 140±
PROPOSED WORK: LEASE NO. 125397

DRILL CONVERT DRILL DEEPER REDRILL FRACTURE OR STIMULATE PLUG OFF OLD FORMATION PERFORATE NEW FORMATION PLUG AND ABANDON CLEAN OUT AND REPLUG OTHER

PHYSICAL CHANGE IN WELL (SPECIFY) _____ TARGET FORMATION MARCELLUS
ESTIMATED DEPTH 7531'

WELL OPERATOR EQT PRODUCTION COMPANY DESIGNATED AGENT JASON RANSON
ADDRESS 115 PROFESSIONAL PLACE P.O. BOX 280 BRIDGEPORT, WV 26330 ADDRESS 115 PROFESSIONAL PLACE P.O. BOX 280 BRIDGEPORT, WV 26330

BOTTOM HOLE LONGITUDE 80°32'30" TOP HOLE LONGITUDE 80°32'30" COUNTY NAME PERMIT

**BIG245
BIG245H8
EQT PRODUCTION COMPANY**

BOTTOM HOLE LATITUDE 39°37'30" 10,572'

LEASE NO.
704417
697P

(S.P.C. NORTH ZONE) (UTM(M) ZONE 17 NORTH)

NAD'27 S.P.C.(FT)	N. 400,676.62	E. 1,698,751.10
NAD'27 GEO.	LAT-(N) 39.595169	LONG-(W) 80.569038
NAD'83 UTM (M)	N. 4,382,924.508	E. 537,019.345
LANDING POINT		
NAD'27 S.P.C.(FT)	N. 406,741.06	E. 1,698,533.00
NAD'27 GEO.	LAT-(N) 39.595339	LONG-(W) 80.569814
NAD'83 UTM (M)	N. 4,382,943.030	E. 536,952.572
BOTTOM HOLE		
NAD'27 S.P.C.(FT)	N. 406,795.66	E. 1,695,962.97
NAD'27 GEO.	LAT-(N) 39.611876	LONG-(W) 80.562192
NAD'83 UTM (M)	N. 4,384,774.543	E. 536,188.851

02/08/2019

LEGEND

LEASE LINE	---
SURFACE LINE	----
WELL LATERAL	=====
OFFSET LINE	-----
TIE LINE	-----
CREEK	~~~~~
ROAD	-----
COUNTY ROUTE	⊖
PROPOSED WELL	⊙
EXISTING WELL	⊛
PERMITTED WELL	⊙
DRILL PATH BEND POINT	▲
GRANT DISTRICT TAX MAP-PARCEL	G-TM-00-00

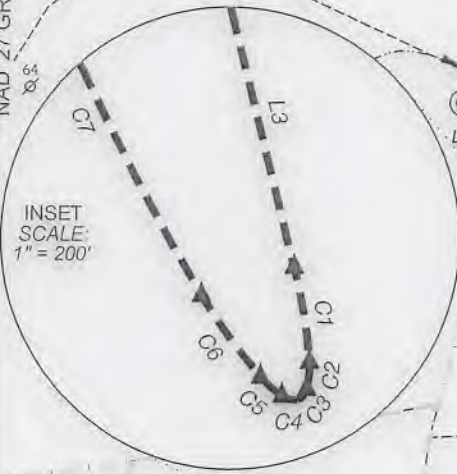
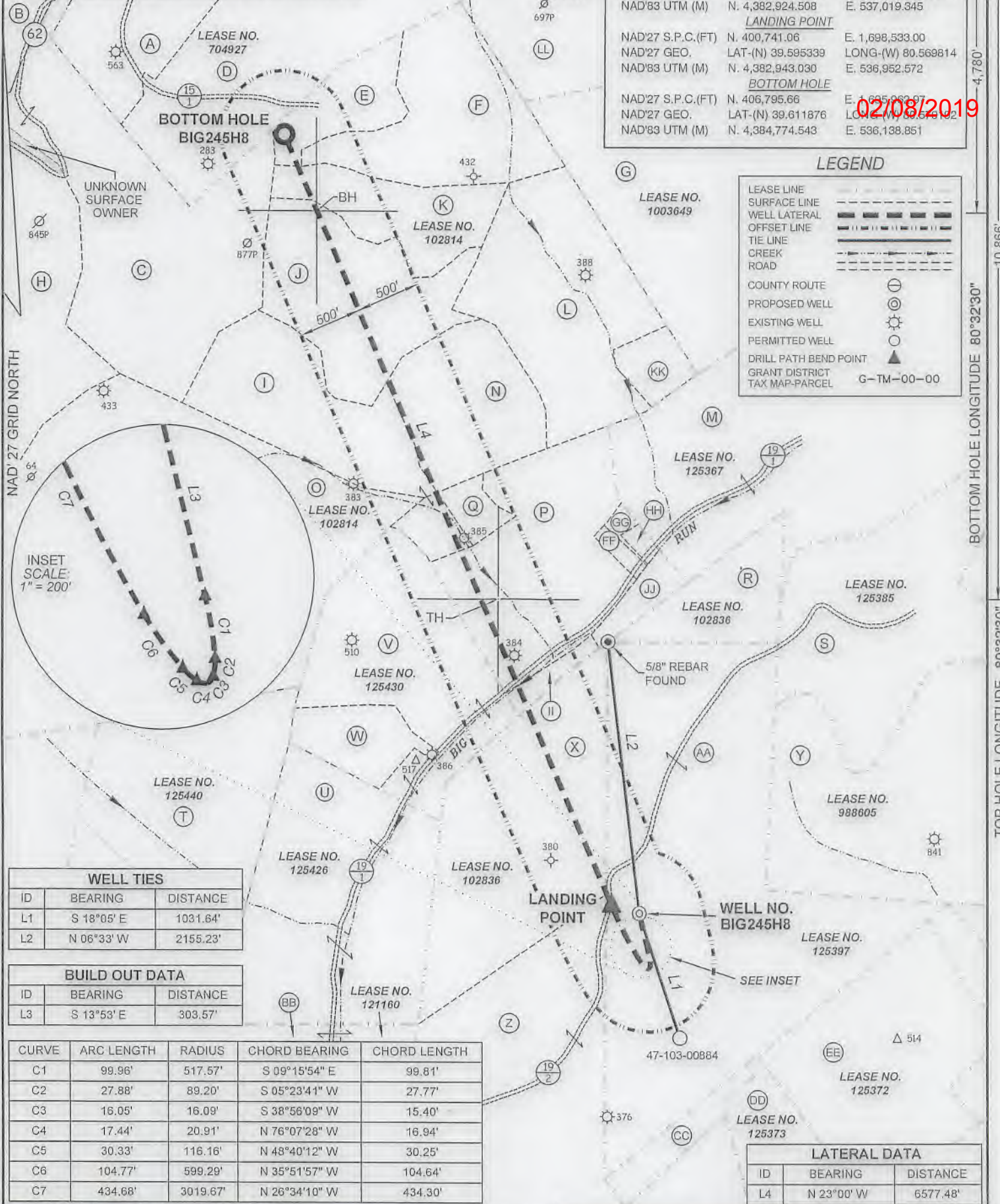

WELL TIES

ID	BEARING	DISTANCE
L1	S 18°05' E	1031.64'
L2	N 06°33' W	2155.23'

BUILD OUT DATA

ID	BEARING	DISTANCE
L3	S 13°53' E	303.57'

CURVE	ARC LENGTH	RADIUS	CHORD BEARING	CHORD LENGTH
C1	99.96'	517.57'	S 09°15'54" E	99.81'
C2	27.88'	89.20'	S 05°23'41" W	27.77'
C3	16.05'	16.09'	S 38°56'09" W	15.40'
C4	17.44'	20.91'	N 76°07'28" W	16.94'
C5	30.33'	116.16'	N 48°40'12" W	30.25'
C6	104.77'	599.29'	N 35°51'57" W	104.64'
C7	434.68'	3019.67'	N 26°34'10" W	434.30'

LATERAL DATA

ID	BEARING	DISTANCE
L4	N 23°00' W	6577.48'



Land & Energy Development
Solutions from the ground up.
P.O. Box 150 • 12 Vanhook Drive • Glenville, WV 26351 • (304) 462-5834
www.slsurveys.com



(+) DENOTES LOCATION OF WELL ON UNITED STATES TOPOGRAPHIC MAPS.
FILE NO. 7812PBIG245H8-R3.dwg SCALE 1"=1000'
DATE MAY 1, 2018
REVISED 08/06/18, 11/15/18, 11/30/18
OPERATORS WELL NO. BIG245H8

I THE UNDERSIGNED, HEREBY CERTIFY THAT THIS PLAT IS CORRECT TO THE BEST OF MY KNOWLEDGE AND BELIEF AND SHOWS ALL THE INFORMATION REQUIRED BY LAW AND THE REGULATIONS ISSUED AND PRESCRIBED BY THE DIVISION OF ENVIRONMENTAL PROTECTION.

P.S. 849 C. Victor Moyers

API WELL NO. **47-103-03234**
STATE COUNTY PERMIT

STATE OF WEST VIRGINIA
DIVISION OF ENVIRONMENTAL PROTECTION
OFFICE OF OIL AND GAS



WELL OPERATOR EQT PRODUCTION COMPANY
ADDRESS 115 PROFESSIONAL PLACE P.O. BOX 280 BRIDGEPORT, WV 26330

DESIGNATED AGENT JASON RANSON
ADDRESS 115 PROFESSIONAL PLACE P.O. BOX 280 BRIDGEPORT, WV 26330

BOTTOM HOLE LONGITUDE 80°32'30" TOP HOLE LONGITUDE 80°32'30"

COUNTY NAME PERMIT