



---

west virginia department of environmental protection

---

Office of Oil and Gas  
601 57<sup>th</sup> Street, S.E.  
Charleston, WV 25304  
(304) 926-0450  
fax: (304) 926-0452

Austin Caperton, Cabinet Secretary  
[www.dep.wv.gov](http://www.dep.wv.gov)

Tuesday, December 18, 2018  
PERMIT MODIFICATION APPROVAL  
Horizontal 6A / New Drill

NORTHEAST NATURAL ENERGY LLC  
707 VIRGINIA STREET EAST  
STE 1200  
CHARLESTON, WV 25301

Re: Permit Modification Approval for BOGGESS 1H  
47-061-01811-00-00

**Lateral Extension**

NORTHEAST NATURAL ENERGY LLC

The Office of Oil and Gas has reviewed the attached permit modification for the above referenced permit. The attached modification has been approved and well work may begin. Please be reminded that the oil and gas inspector is to be notified twenty-four (24) hours before permitted well work is commenced.

If there are any questions, please feel free to contact me at (304) 926- 0450.

James A. Martin  
Chief

A handwritten signature in blue ink, appearing to read "James A. Martin", is written over the typed name and title.

Operator's Well Number: BOGGESS 1H  
Farm Name: BLAKE R. & PRESTON H BOGGESS  
U.S. WELL NUMBER: 47-061-01811-00-00  
Horizontal 6A New Drill  
Date Modification Issued: December 18,2018

WW-6B  
(04/15)

API NO. 47-~~061~~ - ~~01811~~ **12/21/2018**

OPERATOR WELL NO. Bogges 1H  
Well Pad Name: Bogges

STATE OF WEST VIRGINIA  
DEPARTMENT OF ENVIRONMENTAL PROTECTION, OFFICE OF OIL AND GAS  
WELL WORK PERMIT APPLICATION

1) Well Operator: Northeast Natural Energy LLC 494498281 Monongalia Clay Osage, WV  
Operator ID County District Quadrangle

2) Operator's Well Number: Bogges 1H Well Pad Name: Bogges

3) Farm Name/Surface Owner: Blake R. & H. Preston Bogges Public Road Access: Mason Dixon Hwy (State Rt 7)

4) Elevation, current ground: 1,280' Elevation, proposed post-construction: 1,268'

5) Well Type (a) Gas  Oil  Underground Storage   
Other

(b) If Gas Shallow  Deep   
Horizontal

6) Existing Pad: Yes or No No

*Mgk 9/26/2018*

7) Proposed Target Formation(s), Depth(s), Anticipated Thickness and Expected Pressure(s):  
Marcellus, 8,076.5', 103', 3,600 psi

8) Proposed Total Vertical Depth: 8,074'

9) Formation at Total Vertical Depth: Marcellus

10) Proposed Total Measured Depth: 21,048'

11) Proposed Horizontal Leg Length: 12,501'

12) Approximate Fresh Water Strata Depths: 50' ; 1,209'

13) Method to Determine Fresh Water Depths: Driller's Log from Offset Wells

14) Approximate Saltwater Depths: 1,784' ; 2,435'

15) Approximate Coal Seam Depths: 934' ; 1,207'

16) Approximate Depth to Possible Void (coal mine, karst, other): N/A

17) Does Proposed well location contain coal seams directly overlying or adjacent to an active mine? Yes  No

(a) If Yes, provide Mine Info: Name: \_\_\_\_\_  
Depth: \_\_\_\_\_  
Seam: \_\_\_\_\_  
Owner: \_\_\_\_\_

RECEIVED  
Office of Oil and Gas  
SEP 28 2018

WV Department of  
Environmental Protection

18) CASING AND TUBING PROGRAM

TYPE	Size (in)	New or Used	Grade	Weight per ft. (lb/ft)	FOOTAGE: For Drilling (ft)	INTERVALS: Left in Well (ft)	CEMENT: Fill-up (Cu. Ft.)/CTS
Conductor	24"	New	NA	94.71	40'	40'	GTS
Fresh Water	13-3/8"	New	J-55	54.5	1,290'	1,260'	CTS
Coal							
Intermediate	9-5/8"	New	J-55	40	2,530'	2,500'	CTS
Production	5-1/2"	New	P-110	20	21,048'	21,018'	5,008 Cu. Ft.
Tubing	2-7/8"	New	N-80	6.5	NA	8,500'	NA
Liners							

Northeast Natural Energy LLC requests the ability to drill beyond elevation for the purpose of isolating the Red Rock Formation.

*MDK 9/26/18*

TYPE	Size (in)	Wellbore Diameter (in)	Wall Thickness (in)	Burst Pressure (psi)	Anticipated Max. Internal Pressure (psi)	Cement Type	Cement Yield (cu. ft./k)
Conductor	24"	30"	.375	415		4,500 pst Grout	NA
Fresh Water	13-3/8"	17 1/2"	.38"	2,760	2,000	Type 1	1.18
Coal							
Intermediate	9-5/8"	12 1/4"	.395"	3,950	3,000	Type 1	1.18
Production	5-1/2"	8 3/4"	.361"	12,530	9,700	50:50 Poz	1.21
Tubing	2-7/8"	NA	.217"	10,570	3,600	NA	NA
Liners							

PACKERS

Kind:				
Sizes:				RECEIVED Office of Oil and Gas
Depths Set:				SEP 28 2018

WV Department of  
Environmental Protection

19) Describe proposed well work, including the drilling and plugging back of any pilot hole:

Drilling and completion of a horizontal Marcellus well. The well will be drilled on air to an approximate depth of 6,394' TVD/MD. The well will then be horizontally drilled on synthetic based mud from the KOP to approximately 8,074' TVD / 21,048' MD along a 329° azimuth.

20) Describe fracturing/stimulating methods in detail, including anticipated max pressure and max rate:

Multi-stage / high-rate slickwater fracture treatment using various size sands as proppant. First stage will be initiated via pressurization against a burst disc ran in the production casing string or perforated with coiled tubing. Subsequent stages will be perforated with pumped down guns ran on wireline. Individual stages will be isolated with composite frac plugs. Maximum pump rate during any stage will be 110 BPM with a maximum allowable surface pressure of 9,500 PSI. Composite bridge plugs will be set at the end of the last stage to isolate the treated formation.

21) Total Area to be disturbed, including roads, stockpile area, pits, etc., (acres): 20.18

22) Area to be disturbed for well pad only, less access road (acres): 11.67

23) Describe centralizer placement for each casing string:

Surface and intermediate casing strings will have bow spring centralizers placed every third joint (~120') from the shoe joint to surface. Production casing will have rigid body centralizers placed at a minimum of every fourth joint (~160') from TD to surface.

24) Describe all cement additives associated with each cement type:

Surface string cement will be a Type 1 + Max 3% bwoc Calcium Chloride Fresh Water blend. Intermediate string cement will be a Type 1 Cement + Max 3% bwoc Calcium Chloride + Fresh Water. Production string cement will be (50:50) Poz (Fly Ash):Type I Cement with a gas migration additive.

25) Proposed borehole conditioning procedures:

Surface string will use a 25.0 bbls Gel Pill + LCM + 25 lbs Cello Flake + 20 lbs/bbl Bentonite @ 8.4 ppg & 10 bbls fresh water spacer prior to cement. Intermediate string will use a 25.0 bbls Gel Pill + LCM + 25 lbs Cello Flake + 20 lbs/bbl Bentonite @ 8.4 ppg & 10 bbls fresh water spacer prior to cement. Production string will use a 50.0 bbls SealBond 25 + 1 gal/bbl US-40 + 275 lbs/bbl Barite + 1 gal/bbl SS-2 Spacer @ 13.5 ppg prior to cement.

RECEIVED  
Office of Oil and Gas  
SEP 28 2018  
WV Department of  
Environmental Protection

\*Note: Attach additional sheets as needed.

# NORTHEAST NATURAL ENERGY, LLC

Location: Monongalia County, WV  
 Field: Monongalia  
 Facility: Boggess Pad

Slot: Slot 01  
 Well: Boggess 1H  
 Wellbore: Boggess 1H PWB



Location Information				
Facility Name	Grid East (US ft)	Grid North (US ft)	Latitude	Longitude
Boggess Pad	1801481.600	426749.600	39°40'12.490"N	80°05'36.030"W
Slot	Local N (ft)	Local E (ft)	Grid East (US ft)	Grid North (US ft)
Slot 01	-0.07	-0.13	1801481.470	426749.530
			Latitude	Longitude
			39°40'12.490"N	80°05'36.031"W
Ground Level (GL) to Ground level (At Slot: Slot 01)				0ft
Mean Sea Level to Ground level (At Slot: Slot 01)				-1266ft
Ground Level (GL) to Mean Sea Level				1266ft

Type	Hole Size	Casing Size	Grade		GL Depth (Csg)
Conductor	28"	24"	NA		40'
Surface	17-1/2"	13-3/8"	J-55	54.5	1260'
Intermediate	12-1/4"	9-5/8"	J-55	40	2500'

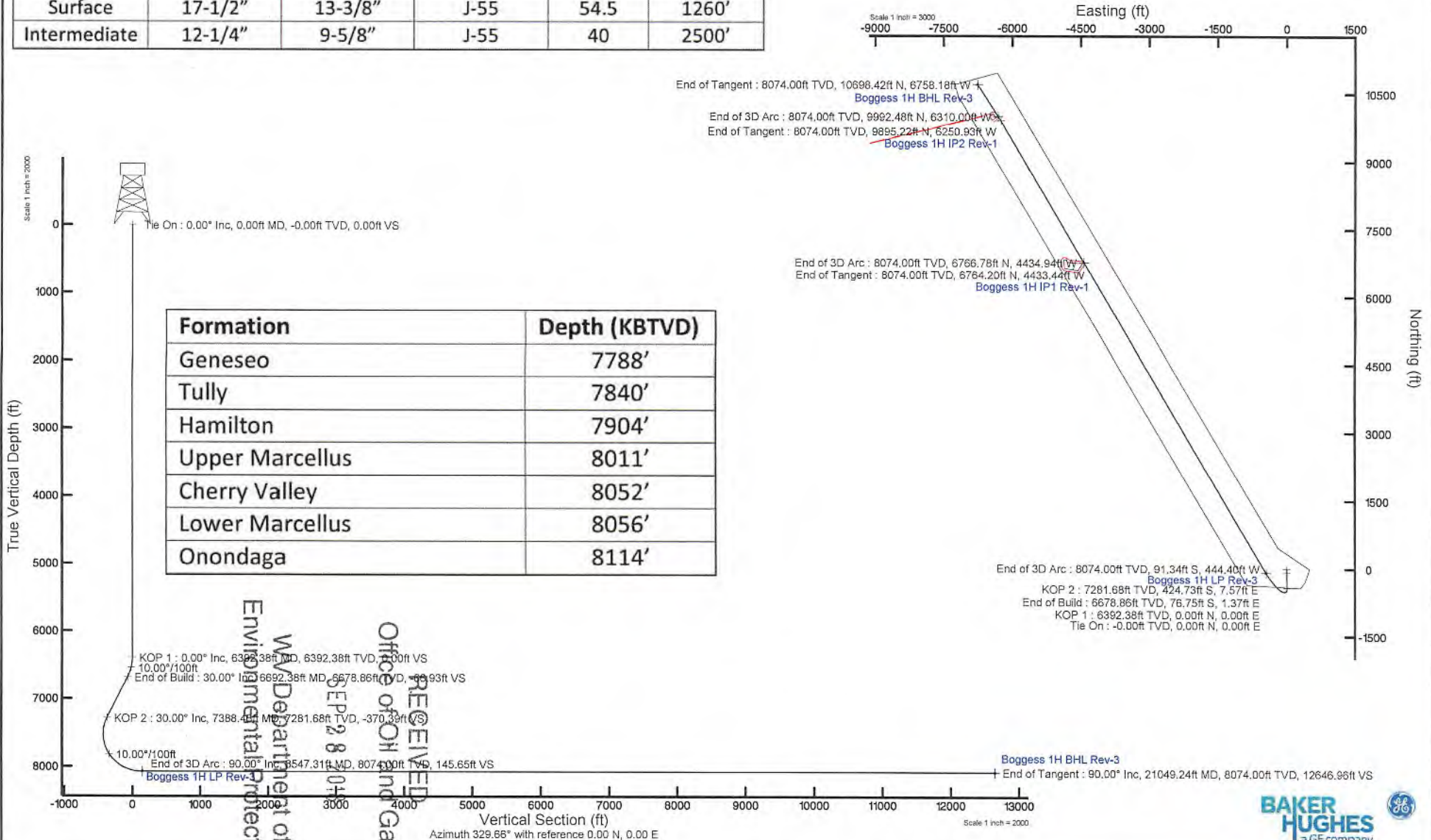

PARCEL ID	PROPERTY OWNER	LEASE NUMBER	ACREAGE
A 11-04-0012-0056-0001	NICHOLAS J. TENNANT & KRISTINA TENNANT	WV-04-00012-002-1A	1.5783
B 11-04-0012-0004-0000	DAVID TUCKER	WV-04-00012-003-1A	.2126

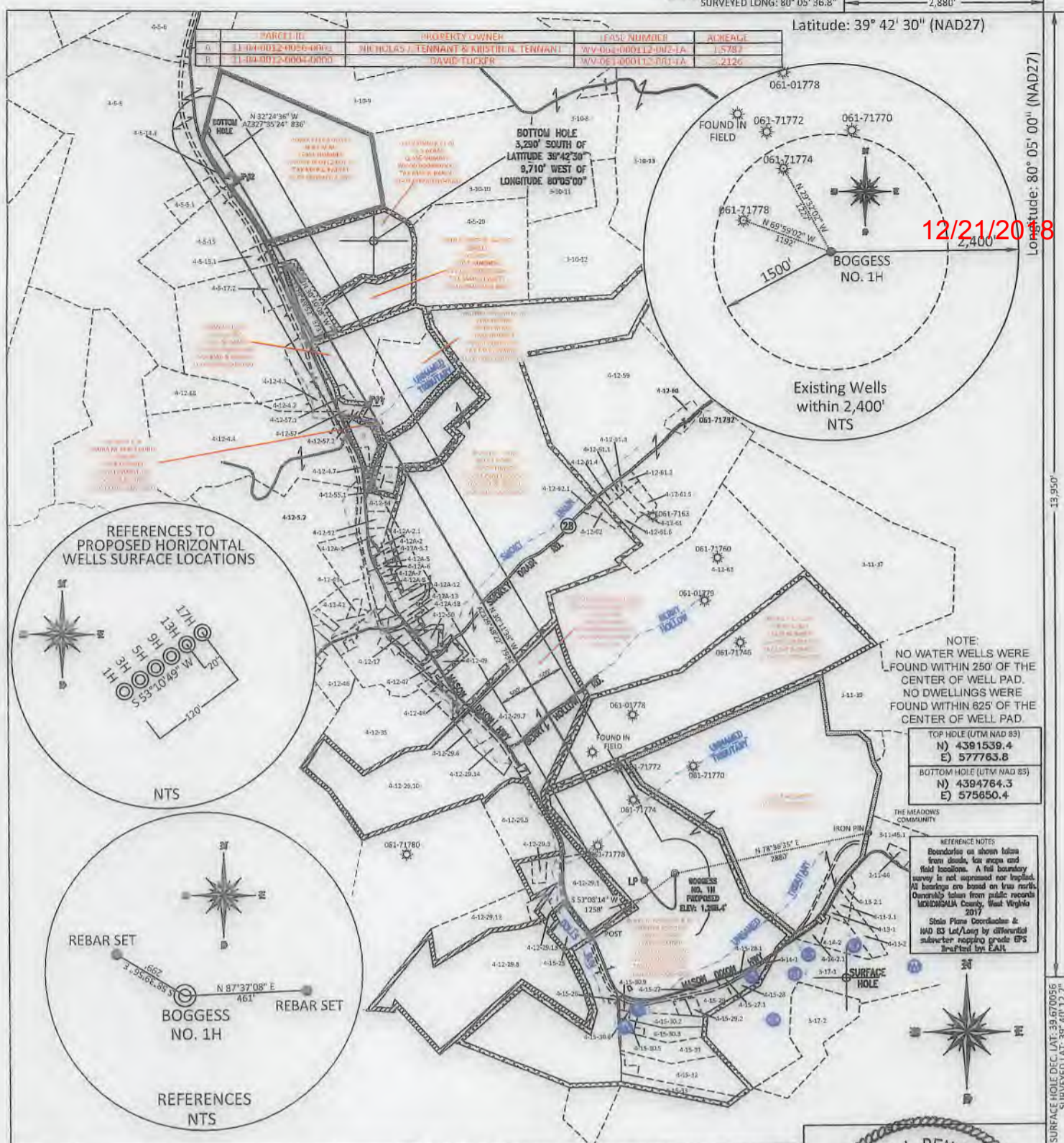

12/21/2018

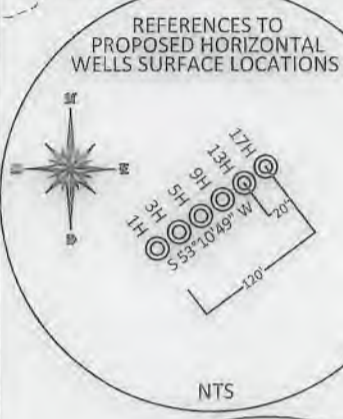

NOTE:  
 NO WATER WELLS WERE FOUND WITHIN 250' OF THE CENTER OF WELL PAD.  
 NO DWELLINGS WERE FOUND WITHIN 825' OF THE CENTER OF WELL PAD.

TOP HOLE (UTM NAD 83)  
 N) 4391539.4  
 E) 577763.8  
 BOTTOM HOLE (UTM NAD 83)  
 N) 4394764.3  
 E) 575850.4

REFERENCE NOTES:  
 Boundaries as shown herein from clouds, fee areas and field locations. A full boundary survey is not expressed nor implied. All bearings are based on true north. Ownership taken from public records MONONGALIA County, West Virginia 2017.  
 State Plane Coordinator & NAD 83 Lat/Long by differential submeter receiving grade GPS tracked by EALT.

FILE #: NEE14  
 DRAWING #: 2862  
 SCALE: PLAT: 1" = 2000'  
TICK MARK: 1" = 2000'  
 MINIMUM DEGREE OF ACCURACY: 1/200  
 PROVEN SOURCE OF ELEVATION: SUBMETER MAPPING GRADE GPS

I, THE UNDERSIGNED, HEREBY CERTIFY THAT THIS PLAT IS CORRECT TO THE BEST OF MY KNOWLEDGE AND BELIEF AND SHOWS ALL THE INFORMATION REQUIRED BY LAW AND THE REGULATIONS ISSUED AND PRESCRIBED BY THE DEPARTMENT OF ENVIRONMENTAL PROTECTION.  
 Signed: [Signature]  
 L.L.S. #2124 Ernest J. Benchek III

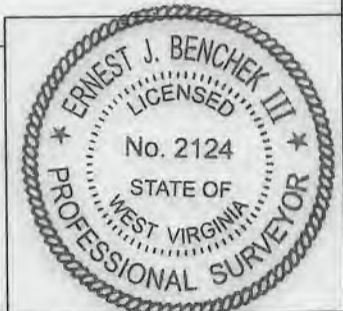

(+) DENOTES LOCATION OF WELL ON UNITED STATES TOPOGRAPHIC MAPS WVDEP  
 OFFICE OF OIL & GAS  
 601 57TH STREET  
 CHARLESTON, WV 25304  
 Well Type:  Oil  Waste Diposal  Production  Deep  
 Gas  Liquid Injection  Storage  Shallow  
 WATERSHED: DUNKARD CREEK  
 COUNTY/DISTRICT: MONONGALIA / CLAY  
 SURFACE OWNER: BLAKE R. & PRESTON H. BOGESS  
 OIL & GAS ROYALTY OWNER: BLAKE R. & PRESTON H. BOGESS 'et al'  
 LEASE NUMBERS: \_\_\_\_\_  
 DRILL  CONVERT  DRILL DEEPER  REDRILL  FRACTURE OR STIMULATE   
 PLUG OFF FORMATION  PERFORATE NEW FORMATION  PLUG & ABANDON   
 CLEAN OUT & REPLUG  OTHER CHANGE  (SPECIFY): \_\_\_\_\_  
 TARGET FORMATION: MARCELLUS  
 WELL OPERATOR: NORTHEAST NATURAL ENERGY LLC  
 ADDRESS: 707 VIRGINIA STREET EAST, SUITE 1200  
 CITY: CHARLESTON STATE: WV ZIP CODE: 25301  
 DATE: September 26, 2018  
 OPERATOR'S WELL #: BOGESS NO. 1H  
 API WELL #: 47 61 47-061-01811  
 STATE COUNTY PERMIT  
 PROPOSED ELEVATION: 1,265.4'  
 QUADRANGLE: OSAGE, WV  
 ACREAGE: 389.96 +/-  
 ACREAGE: 1075.72 +/-  
 ESTIMATED DEPTH: TVD: 8,074' TMD: 21,049'  
 DESIGNATED AGENT: JOHN ADAMS  
 ADDRESS: 707 VIRGINIA STREET EAST, SUITE 1200  
 CITY: CHARLESTON STATE: WV ZIP CODE: 25301

# BOGGESS 1H EXISTING GAS WELLS September 26, 2018

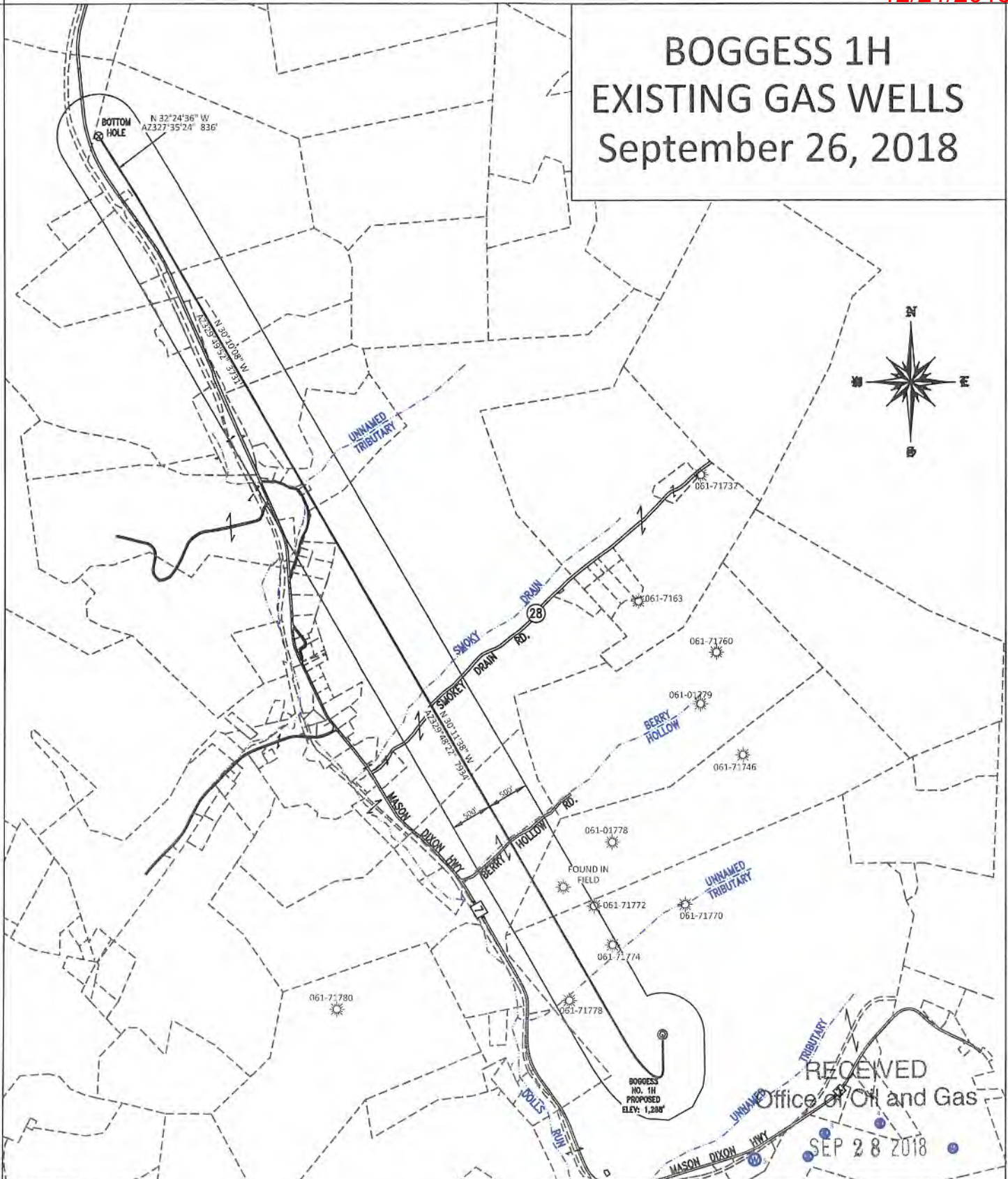

RECEIVED  
Office of Oil and Gas  
SEP 28 2018

SCALE: 1" = 1,600'  
WV Department of  
Environmental Protection



## Bogges 1H Area of Review

API Number	Well Name	Well Number	Operator	Latitude (NAD 83)	Longitude (NAD 83)	TMP	TVD	Comments
061-71778	D E & L Lemley	3	NA	39.671113	-80.096262	4-12-65	NA	pre 1929
061-71774	D E & L Lemley	4	NA	39.672709	-80.095323	4-12-65	NA	pre 1929
061-71772	D E & L Lemley	NA	NA	39.674161	-80.096261	4-12-65	NA	pre 1929
FOUND IN FIELD	NA	NA	NA	39.674957	-80.097630	4-12-64	NA	NA

RECEIVED  
Office of Oil and Gas

SEP 28 2018

WV Department of  
Environmental Protection



WW-6A1  
(5/13)

Operator's Well No. Bogges 1H

**INFORMATION SUPPLIED UNDER WEST VIRGINIA CODE  
Chapter 22, Article 6A, Section 5(a)(5)  
IN LIEU OF FILING LEASE(S) AND OTHER CONTINUING CONTRACT(S)**

Under the oath required to make the verification on page 1 of this Notice and Application, I depose and say that I am the person who signed the Notice and Application for the Applicant, and that –

- (1) the tract of land is the same tract described in this Application, partly or wholly depicted in the accompanying plat, and described in the Construction and Reclamation Plan;
- (2) the parties and recordation data (if recorded) for lease(s) or other continuing contract(s) by which the Applicant claims the right to extract, produce or market the oil or gas are as follows:

Lease Name or Number	Grantor, Lessor, etc.	Grantee, Lessee, etc.	Royalty	Book/Page
See Attachment				

**Acknowledgement of Possible Permitting/Approval  
In Addition to the Office of Oil and Gas**

The permit applicant for the proposed well work addressed in this application hereby acknowledges the possibility of the need for permits and/or approvals from local, state, or federal entities in addition to the DEP, Office of Oil and Gas, including but not limited to the following:

- WV Division of Water and Waste Management
- WV Division of Natural Resources WV Division of Highways
- U.S. Army Corps of Engineers
- U.S. Fish and Wildlife Service
- County Floodplain Coordinator

RECEIVED  
Office of Oil and Gas

The applicant further acknowledges that any Office of Oil and Gas permit in no way overrides, replaces, or nullifies the need for other permits/approvals that may be necessary and further affirms that all needed permits/approvals should be acquired from the appropriate authority before the affected activity is initiated.

SEP 28 2018

WV Department of  
Environmental Protection

Well Operator: Northeast Natural Energy LLC  
 By: Hollie Medley *Hollie Medley*  
 Its: Regulatory Manager

WW-6A1

Bogges 1H

NNE LEASE NUMBER	LESSOR NAME	LESSEE NAME	ROYALTY	BOOK/	PG
WV 061 003592 001	Shuman Inc. a West Virginia Corporation	Northeast Natural Energy LLC	0.125 Or Greater	1526	462
WV 061 003269 003	Blake R. Bogges	Northeast Natural Energy LLC	0.125 Or Greater	1509	698
WV 061 003269 004	H. Preston Bogges	Northeast Natural Energy LLC	0.125 Or Greater	1510	607
WV 061 003363 002	Sanford Barrickman	South Penn Oil Co.	0.125 Or Greater	100	39
WV 061 001368 001	June C. Myers	CHESAPEAKE APPALACHIA, L.L.C.	0.125 Or Greater	1374	205
WV 061 001368 002	Joy S. Henderson, AKA Joy Sue Henderson	CHESAPEAKE APPALACHIA, L.L.C.	0.125 Or Greater	1377	166
WV 061 001368 003	June Core Myers, as Trustee of the June Core Myers Living Trust	Northeast Natural Energy LLC	0.125 Or Greater	1601	817
WV 061 003586 001	Charles L. Core a/k/a Charles Lawrence Core, a single man	Northeast Natural Energy LLC	0.125 Or Greater	1523	710
WV 061 003586 002	Kimberly Dawn Schnopp	Northeast Natural Energy, LLC	0.125 Or Greater	1600	590
WV 061 004265 001	Susan Beth Kish, a/k/a Susan Core Kish	Northeast Natural Energy LLC	0.125 Or Greater	1571	574
WV 061 004267 001	Beverly J. Core	Northeast Natural Energy LLC	0.125 Or Greater	1571	578
WV 061 004308 001	William B. Core and Neoma K. Core	Northeast Natural Energy LLC	0.125 Or Greater	1573	476
WV 061 004404 001	Westhawk Minerals LLC	Gulfport Energy Corporation	0.125 Or Greater	1576	481
WV 061 003485 001	Harold Eugene DeGarmo, Jr., a married man dealing in his sole and separate property	Northeast Natural Energy LLC	0.125 Or Greater	1517	843
WV 061 003485 002	Wanda N. Ignance, a married woman dealing in her sole and separate property	Northeast Natural Energy LLC	0.125 Or Greater	1517	0391
WV 061 003485 003	Alan Boyd Core, a married man dealing in his sole and separate property	Northeast Natural Energy LLC	0.125 Or Greater	1517	0393
WV 061 003485 004	Karen Marlele Core, a single woman	Northeast Natural Energy LLC	0.125 Or Greater	1521	139
WV 061 003485 006	Tanis L. Domarsky, a single woman	Northeast Natural Energy LLC	0.125 Or Greater	1517	352
WV 061 003485 007	Virginia Elaine Carter, a single woman	Northeast Natural Energy LLC	0.125 Or Greater	1517	346
WV 061 003485 008	Tracey Lynne Dornberger, a single woman	Northeast Natural Energy LLC	0.125 Or Greater	1517	364
WV 061 003485 009	Denise Marie Kakascik, a married woman dealing in her sole and separate property	Northeast Natural Energy LLC	0.125 Or Greater	1521	709
WV 061 003485 010	Darlene E. Kerwood, a married woman dealing in sole and separate property	Northeast Natural Energy LLC	0.125 Or Greater	1517	0397
WV 061 003485 011	Romayne L. Grim, a married woman dealing in her sole and separate	Northeast Natural Energy LLC	0.125 Or Greater	1516	0771
WV 061 003485 012	Douglas E. Barcus, a single man	Northeast Natural Energy LLC	0.125 Or Greater	1517	358
WV 061 003485 013	Dale J. Barcus Jr. a single man	Northeast Natural Energy LLC	0.125 Or Greater	1519	820
WV 061 003485 014	Richard M. Carter Sr., a single man	Northeast Natural Energy LLC	0.125 Or Greater	1523	789
WV 061 003485 015	Marsha Lynn Core f/k/a Marsha Lynn Bobnak, a single woman	Northeast Natural Energy LLC	0.125 Or Greater	1524	321
WV 061 003485 016	Carol Ann Garcia, a married woman dealing in her sole and separate property	Northeast Natural Energy LLC	0.125 Or Greater	1524	443
WV 061 003485 017	Tyra Kay Greene, a married woman dealing in her sole and separate property	Northeast Natural Energy LLC	0.125 Or Greater	1526	94
WV 061 003485 018	Craig Bennett Core, a married man dealing in his sole and separate property	Northeast Natural Energy LLC	0.125 Or Greater	1524	340
WV 061 003485 019	Michael Bruce Hancock	Northeast Natural Energy LLC	0.125 Or Greater	1528	97
WV 061 003485 020	Donald Richard Blackburn and Linda Lou Blackburn	Northeast Natural Energy LLC	0.125 Or Greater	1541	319
WV 061 003485 021	John Wayne Blackburn	Northeast Natural Energy LLC	0.125 Or Greater	1535	714
WV 061 003485 022	Courtney L. Dalrymple	Northeast Natural Energy LLC	0.125 Or Greater	1536	275
WV 061 003485 026	Brandon Jon Dalrymple and Melinda K. Dalrymple	Northeast Natural Energy LLC	0.125 Or Greater	1565	451
WV 061 003485 027	Melva Lynn Marcum and Michael C. Marcum	Northeast Natural Energy LLC	0.125 Or Greater	1564	329
WV 061 003485 029	Ferri Sue Yanda	Northeast Natural Energy LLC	0.125 Or Greater	1604	388
WV 061 003485 030	Donna J. Yanda	Northeast Natural Energy LLC	0.125 Or Greater	1604	390
WV 061 003631 001	Charles L. Core aka Charles Lawrence Core	Northeast Natural Energy LLC	0.125 Or Greater	1535	637
WV 061 004690 004	Edna M. Carmichael	Northeast Natural Energy LLC	0.125 Or Greater	1604	244
WV 061 004690 005	Daniel E. Strupe	Northeast Natural Energy LLC	0.125 Or Greater	1604	420
WV 061 004690 006	Donna J. Schayes	Northeast Natural Energy, LLC	0.125 Or Greater	1604	422
WV 061 004690 007	Brian A. Ware	Northeast Natural Energy LLC	0.125 Or Greater	1604	424
WV 061 004690 008	Debra D. Sanz	Northeast Natural Energy LLC	0.125 Or Greater	1604	426
WV 061 004690 009	Cathy L. Sahli	Northeast Natural Energy LLC	0.125 Or Greater	1606	106
WV 061 004690 010	Donna Sue Richards	Northeast Natural Energy LLC	0.125 Or Greater	1606	108
WV 061 004690 013	Della K. Strupe	Northeast Natural Energy LLC	0.125 Or Greater	1606	110
WV 061 004690 016	Kimberly A. Dombo and Robert J. Dombo Jr.,	Northeast Natural Energy LLC	0.125 Or Greater	1606	114

Environmental Protection  
 Office of Oil and Gas  
 RECEIVED  
 SEP 18 2018

**WW-6A1**

**Bogges 1H**

**NNE LEASE NUMBER**

**LESSOR NAME**

**LESSEE NAME**

**ROYALTY**

**BOOK/ PG**

WV 061 004690 017	Carrie Jean Edwards
WV 061 004690 018	Betty Joann Carmichael
WV 061 004690 020	John P. Domarsky and Michelle L. Domarsky
WV 061 004690 021	Connie L Cotterman f/k/a and Terry L Cotterman
WV 061 004690 022	David E. Barcus
WV 061 004690 025	Ralph W. Carter and Sandra K. Carter
WV 061 004690 026	William B. Myrtle
WV 061 004690 027	Angela S. Griesenauer, fka Angela S. Myrtle
WV 061 004858 002	Judy Mosser
WV 061 004858 005	Timothy J. Menke Jr.
WV 061 004858 006	Angelique Anderson, f/k/a Angeliique Menke and Kristopher Anderson
WV 061 004858 009	Tracey M. Keck
WV 061 004858 011	Mary E. Kambach
WV 061 004858 012	Keith W. Smith and Sheri L. Smith
WV 061 004858 019	Joni Lynn Metoxen
WV 061 004858 020	Chris Hamilton
WV 061 004858 023	Kimberly C. Krajewski f/k/a Kimberly C. Menke
WV 061 004691 002	Craig Bennett Core
WV 061 004691 003	Donald Richard Blackburn and Linda Lou Blackburn
WV 061 004691 005	Romayne L. Grim, f/k/a Romayne L. Degarmo and Ronald D. Grim
WV 061 004691 006	Kelly Thomas
WV 061 004691 007	Darlene E. Kerwood, f/k/a Darlene E. Degarmo
WV 061 004691 008	Courtney L. Dalrymple
WV 061 004691 010	Tanis L. Domarsky
WV 061 004691 012	James Brian Malone
WV 061 004691 013	Bethany Leigh Meyers
WV 061 004691 014	Tyra Kaye Greene
WV 061 004691 015	Donna J. Yanda
WV 061 004691 016	David Lynn Barker
WV 061 004691 017	Terri Sue Yanda
WV 061 004691 018	Brandon J. Dalrymple and Melinda K. Dalrymple
WV 061 004691 019	Carol A. Garcia, f/k/a Carol A Dalrymple and Manual B. Garcia, Jr.
WV 061 004691 020	Kirk G. Yanda
WV 061 004691 021	Melva Lynn Marcum and Michael C. Marcum
WV 061 004691 023	Dale J. Barcus Jr.
WV 061 004691 024	Tracey Lynne Dornberger
WV 061 004691 025	Patrick Wayne Blackburn
WV 061 004691 026	Carol E. Degarmo Jr. and Mary B Degarmo
WV 061 004691 028	Barbara Buckmaster, a widow, by her Attorney-In-Fact, Bobby Caruso
WV 061 004691 029	Douglas Barcus
WV 061 004691 030	Michelle Bruce Hancock
WV 061 004699 001	Richard Carter Jr.
WV 061 004690 004	Dina M. Carmichael
WV 061 004690 005	Daniel E. Strupe
WV 061 004690 006	Chris J. Schayes
WV 061 004690 007	Brian A. Ware
WV 061 004690 008	Danika D. Sanz
WV 061 004690 009	Cathy L. Sahli

Northeast Natural Energy LLC	0.125 Or Greater	1608	40
Northeast Natural Energy LLC	0.125 Or Greater	1609	393
Northeast Natural Energy LLC	0.125 Or Greater	1608	42
Northeast Natural Energy LLC	0.125 Or Greater	1611	341
Northeast Natural Energy LLC	0.125 Or Greater	1612	136
Northeast Natural Energy LLC	0.125 Or Greater	1618	603
Northeast Natural Energy LLC	0.125 Or Greater	1619	627
Northeast Natural Energy LLC	0.125 Or Greater	1622	20
Northeast Natural Energy LLC	0.125 Or Greater	1611	831
Northeast Natural Energy LLC	0.125 Or Greater	1618	360
Northeast Natural Energy LLC	0.125 Or Greater	1618	362
Northeast Natural Energy LLC	0.125 Or Greater	1618	639
Northeast Natural Energy LLC	0.125 Or Greater	1618	641
Northeast Natural Energy LLC	0.125 Or Greater	1620	41
Northeast Natural Energy LLC	0.125 Or Greater	1622	602
Northeast Natural Energy LLC	0.125 Or Greater	1622	604
Northeast Natural Energy LLC	0.125 Or Greater	1628	456
Northeast Natural Energy LLC	0.125 Or Greater	1601	560
Northeast Natural Energy LLC	0.125 Or Greater	1601	562
Northeast Natural Energy LLC	0.125 Or Greater	1609	444
Northeast Natural Energy LLC	0.125 Or Greater	1609	446
Northeast Natural Energy, LLC	0.125 Or Greater	1609	448
Northeast Natural Energy LLC	0.125 Or Greater	1609	450
Northeast Natural Energy LLC	0.125 Or Greater	1604	246
Northeast Natural Energy LLC	0.125 Or Greater	1609	475
Northeast Natural Energy LLC	0.125 Or Greater	1609	477
Northeast Natural Energy LLC	0.125 Or Greater	1609	479
Northeast Natural Energy LLC	0.125 Or Greater	1604	428
Northeast Natural Energy LLC	0.125 Or Greater	1604	430
Northeast Natural Energy LLC	0.125 Or Greater	1604	432
Northeast Natural Energy LLC	0.125 Or Greater	1604	434
Northeast Natural Energy LLC	0.125 Or Greater	1604	436
Northeast Natural Energy LLC	0.125 Or Greater	1604	438
Northeast Natural Energy, LLC	0.125 Or Greater	1606	116
Northeast Natural Energy, LLC	0.125 Or Greater	1608	44
Northeast Natural Energy LLC	0.125 Or Greater	1608	46
Northeast Natural Energy, LLC	0.125 Or Greater	1608	48
Northeast Natural Energy LLC	0.125 Or Greater	1611	343
Northeast Natural Energy LLC	0.125 Or Greater	1611	702
Northeast Natural Energy LLC	0.125 Or Greater	1611	704
Northeast Natural Energy LLC	0.125 Or Greater	1615	668
Northeast Natural Energy LLC	0.125 Or Greater	1612	347
Northeast Natural Energy LLC	0.125 Or Greater	1604	244
Northeast Natural Energy LLC	0.125 Or Greater	1604	420
Northeast Natural Energy, LLC	0.125 Or Greater	1604	422
Northeast Natural Energy LLC	0.125 Or Greater	1604	424
Northeast Natural Energy LLC	0.125 Or Greater	1604	426
Northeast Natural Energy LLC	0.125 Or Greater	1606	106

WV Deed Return  
 Office of the State Auditor  
 100 Capitol Building  
 Charleston, WV 25305  
 SEP 28 2018  
 10:42 AM

WW-6A1

Bogess 1H

NNE LEASE NUMBER	LESSOR NAME	LESSEE NAME	ROYALTY	BOOK/	PG
WV 061 004690 010	Donna Sue Richards	Northeast Natural Energy LLC	0.125 Or Greater	1606	108
WV 061 004690 013	Della K. Strupe	Northeast Natural Energy LLC	0.125 Or Greater	1606	110
WV 061 004690 014	Ruth Ann Waltz	Northeast Natural Energy LLC	0.125 Or Greater	1606	112
WV 061 004690 015	Erin Joseph Roat	Northeast Natural Energy LLC	0.125 Or Greater	1605	518
WV 061 004690 016	Kimberly A. Dombo and Robert J. Dombo Jr.,	Northeast Natural Energy LLC	0.125 Or Greater	1606	114
WV 061 004690 017	Carrie Jean Edwards	Northeast Natural Energy LLC	0.125 Or Greater	1608	40
WV 061 004690 018	Betty Joann Carmichael	Northeast Natural Energy LLC	0.125 Or Greater	1609	393
WV 061 004690 019	Tamara Lopretto	Northeast Natural Energy LLC	0.125 Or Greater	1609	395
WV 061 004690 020	John P. Domarsky and Michelle L. Domarsky	Northeast Natural Energy LLC	0.125 Or Greater	1608	42
WV 061 004690 021	Connie L Cotterman f/k/a and Terry I. Cotterman	Northeast Natural Energy LLC	0.125 Or Greater	1611	341
WV 061 004690 022	David E. Barcus	Northeast Natural Energy LLC	0.125 Or Greater	1612	136
WV 061 004690 023	Linda M Swenson, f/l/a Linda M. Degarmo	Northeast Natural Energy LLC	0.125 Or Greater	1612	138
WV 061 004690 025	Ralph W. Carter and Sandra K. Carter	Northeast Natural Energy LLC	0.125 Or Greater	1618	603
WV 061 004690 026	William B. Myrtle	Northeast Natural Energy LLC	0.125 Or Greater	1619	627
WV 061 004690 027	Angela S. Griesenauer, fka Angela S. Myrtle	Northeast Natural Energy LLC	0.125 Or Greater	1622	20
WV 061 004691 002	Craig Bennett Core	Northeast Natural Energy LLC	0.125 Or Greater	1601	560
WV 061 004691 003	Donald Richard Blackburn and Linda Lou Blackburn	Northeast Natural Energy LLC	0.125 Or Greater	1601	562
WV 061 004691 004	Alan Boyd Core and Cathy Jo Core	Northeast Natural Energy, LLC	0.125 Or Greater	1609	442
WV 061 004691 005	Romayne L. Grim, f/k/a Romayne L. Degarmo and Ronald D. Grim	Northeast Natural Energy LLC	0.125 Or Greater	1609	444
WV 061 004691 006	Kelly Thomas	Northeast Natural Energy LLC	0.125 Or Greater	1609	446
WV 061 004691 007	Darlene E. Kerwood, f/k/a Darlene E. Degarmo	Northeast Natural Energy, LLC	0.125 Or Greater	1609	448
WV 061 004691 008	Courtney L. Dalrymple	Northeast Natural Energy LLC	0.125 Or Greater	1609	450
WV 061 004691 009	Wanda N. Ignace and Joel Ignace	Northeast Natural Energy LLC	0.125 Or Greater	1609	452
WV 061 004691 010	Tanis L. Domarsky	Northeast Natural Energy LLC	0.125 Or Greater	1604	246
WV 061 004691 011	Denise Marie Kakascik and Donald Paul Kakascik	Northeast Natural Energy LLC	0.125 Or Greater	1609	473
WV 061 004691 012	James Brian Malone	Northeast Natural Energy LLC	0.125 Or Greater	1609	475
WV 061 004691 013	Bethany Leigh Meyers	Northeast Natural Energy LLC	0.125 Or Greater	1609	477
WV 061 004691 014	Tyra Kaye Greene	Northeast Natural Energy LLC	0.125 Or Greater	1609	479
WV 061 004691 015	Donna J. Yanda	Northeast Natural Energy LLC	0.125 Or Greater	1604	428
WV 061 004691 016	David Lynn Barker	Northeast Natural Energy LLC	0.125 Or Greater	1604	430
WV 061 004691 017	Terri Sue Yanda	Northeast Natural Energy LLC	0.125 Or Greater	1604	432
WV 061 004691 018	Brandon J. Dalrymple and Melinda K. Dalrymple	Northeast Natural Energy LLC	0.125 Or Greater	1604	434
WV 061 004691 019	Carol A. Garcia, f/k/a Carol A Dalrymple and Manual B. Garcia, Jr.	Northeast Natural Energy LLC	0.125 Or Greater	1604	436
WV 061 004691 020	Kirk S. Yanda	Northeast Natural Energy LLC	0.125 Or Greater	1604	438
WV 061 004691 021	Melvin Lynn Marcum and Michael C. Marcum	Northeast Natural Energy, LLC	0.125 Or Greater	1606	116
WV 061 004691 022	Maaha Lynn Core	Northeast Natural Energy LLC	0.125 Or Greater	1606	118
WV 061 004691 023	David J. Barcus Jr.	Northeast Natural Energy, LLC	0.125 Or Greater	1608	44
WV 061 004691 024	Tracy Wine Dornberger	Northeast Natural Energy LLC	0.125 Or Greater	1608	46
WV 061 004691 025	Patrick Wayne Blackburn	Northeast Natural Energy, LLC	0.125 Or Greater	1608	48
WV 061 004691 026	Harold E. Degarmo Jr. and Mary B Degarmo	Northeast Natural Energy LLC	0.125 Or Greater	1611	343
WV 061 004691 028	Karen Buckmaster, a widow, by her Attorney-in-Fact, Bobby Caruso	Northeast Natural Energy LLC	0.125 Or Greater	1611	702
WV 061 004691 029	Douglas Barcus	Northeast Natural Energy LLC	0.125 Or Greater	1611	704
WV 061 004691 030	Michael Bruce Hancock	Northeast Natural Energy LLC	0.125 Or Greater	1615	668
WV 061 004858 001	Ashlyn Strupe	Northeast Natural Energy LLC	0.125 Or Greater	1612	345
WV 061 004858 002	Judith Mosser	Northeast Natural Energy LLC	0.125 Or Greater	1611	831
WV 061 004858 004	Regis Bernard Menke	Northeast Natural Energy LLC	0.125 Or Greater	1618	358
WV 061 004858 005	Timothy J. Menke Jr.	Northeast Natural Energy LLC	0.125 Or Greater	1618	360
WV 061 004858 006	Angelique Anderson, f/k/a Angelique Menke and Kristopher Anderson	Northeast Natural Energy LLC	0.125 Or Greater	1618	362

SEP 28 2018

RECEIVED  
 DEPT OF REVENUE  
 STATE OF WEST VIRGINIA  
 TAX ADMINISTRATION

**WW-6A1****Bogges 1H**

<b>NNE LEASE NUMBER</b>	<b>LESSOR NAME</b>	<b>LESSEE NAME</b>	<b>ROYALTY</b>	<b>BOOK/</b>	<b>PG</b>
WV 061 004858 009	Tracey M. Keck	Northeast Natural Energy LLC	0.125 Or Greater	1618	639
WV 061 004858 011	Mary E. Kambach	Northeast Natural Energy LLC	0.125 Or Greater	1618	641
WV 061 004858 012	Keith W. Smith and Sheri L. Smith	Northeast Natural Energy LLC	0.125 Or Greater	1620	41
WV 061 004858 019	Joni Lynn Metoxen	Northeast Natural Energy LLC	0.125 Or Greater	1622	602
WV 061 004858 020	Chris Hamilton	Northeast Natural Energy LLC	0.125 Or Greater	1622	604
WV 061 004858 023	Kimberly C. Krajewski f/k/a Kimberly C. Menke	Northeast Natural Energy LLC	0.125 Or Greater	1628	456
WV 061 004859 001	Richard Carter Jr.	Northeast Natural Energy LLC	0.125 Or Greater	1612	347
WV 061 004807 003	Alexis D. Howard	Northeast Natural Energy LLC	0.125 Or Greater	1628	431
WV 061 004807 013	Leslie Gail Nunez, f/k/a Leslie Gail Duncan	Northeast Natural Energy LLC	0.125 Or Greater	1628	382
WV 061 004807 018	Timothy J. Howard and Tricia Howard	Northeast Natural Energy LLC	0.125 Or Greater	1628	434
WV 061 004807 020	John R. Goodman and Letitia C. Goodman	Northeast Natural Energy LLC	0.125 Or Greater	1623	33
WV 061 004807 021	Shirley Troth f/k/a Shirley Goodman	Northeast Natural Energy LLC	0.125 Or Greater	1628	437
WV 061 002964 002	Janet Jones Lemley , f/k/a Janet Jones and Wayne Lemley, a/k/a Earl W. Lemley	Northeast Natural Energy LLC	0.125 Or Greater	1612	19
WV 061 004902 001	Gary David Conner, a/k/a G. D. Conner and Karen Gwen Conner	Northeast Natural Energy LLC	0.125 Or Greater	1628	210
WV 061 004902 002	Earl Wayne Lemley and Janet Marie Lemley	Northeast Natural Energy LLC	0.125 Or Greater	1618	338
WV 061 002690 002	Robert L. Statler and Dorothy F. Statler, his wife	Northeast Natural Energy LLC	0.125 Or Greater	1521	746
WV 061 000112 002 LA	EQT Production Company	Northeast Natural Energy LLC	Agreement	1623	663
WV 061 000112 001 LA	XTO Energy Inc.	Northeast Natural Energy LLC	Agreement	1623	380

**RECEIVED**  
Office of Oil and Gas

SEP 28 2018

WV Department of  
Environmental Protection

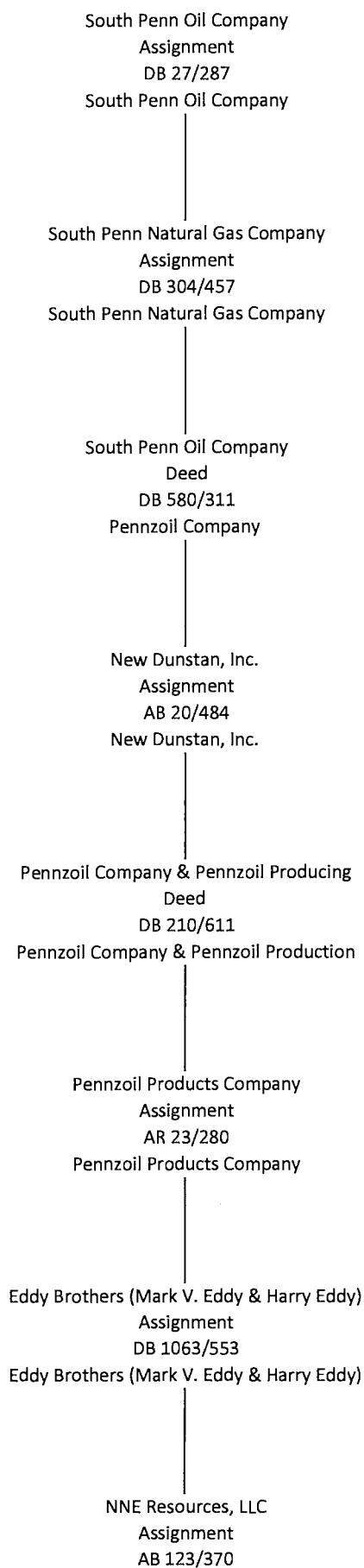

RECEIVED  
Office of Oil and Gas  
SEP 28 2018  
WV Department of  
Environmental Protection

12/21/2018

Chesapeake Appalachia, LLC.  
And  
Statoil USA Onshore Properties Inc.

Northeast Natural Energy  
Assignment  
BK 120/769

RECEIVED  
Office of Oil and Gas

SEP 28 2018

WV Department of  
Environmental Protection

J.W. Berry  
Lease  
DB 25/391  
E.M. Hukill

E.M. Hukill  
Assignment  
AB 31/262  
South Penn Oil Company

South Penn Oil Company  
Assignment  
AB 31/286  
Marion Oil Company

Marion Oil Company  
Assignment  
AB 219/211  
Washington Oil Company

Washington Oil Company  
Assignment  
AB 9/148  
Northern United Petroleum Company

Northern United Petroleum Company  
Assignment  
AB 9/217  
United Petroleum Corporation

Northern United Petroleum Company  
Assignment  
AB 9/282  
United Petroleum Corporation

United Petroleum Corporation  
Assignment  
AB 9/329  
Chill Can International, Ltd.

Chill Can International, Ltd.  
Assignment  
AB 9/677  
Jerome Klubeck

Jerome Klubeck  
Assignment  
AB 65/373  
N-K LLC

N-K LLC  
Assignment  
AB 130/840  
Northeast Natural Energy, LLC

RECEIVED  
Office of Oil and Gas  
SEP 28 2013  
WV Department of  
Environmental Protection



12/21/2018

Westhawk Minerals, LLC  
Lease  
DB 1576/481  
Gulfport Energy Corporation

Gulfport Energy Corporation  
Assignment  
AB 132/537  
Northeast Natural Energy, LLC

RECEIVED  
Office of Oil and Gas

SEP 28 2018

WV Department of  
Environmental Protection

12/21/2018



# northeast

NATURAL ENERGY

## Bogges 1H

### SITE SAFETY PLAN

September 25, 2018

*Harold K. ...*  
9/26/2018

RECEIVED  
Office of Oil and Gas

SEP 28 2018

WV Department of  
Environmental Protection

**SITE NAME** Boggess 1H

**COUNTY** Monongalia

**ACCESS ROAD ENTRANCE** N39° 39' 59.23" , W-80° 05' 48.82 (NAD 83)

N 4391127.465, E 577463.266 (NAD 83 UTM)

**DIRECTIONS TO SITE:**

**From I-79**, take exit 155. Merge onto Chaplin Hill Road/CR-19/24N toward US-19/WV-7/Star City. If traveling from the south, this will be a right off the exit. If traveling from the north, this will be a left off the exit. After approximately 0.8 miles, turn left at light onto US-19/WV-7. Continue on US-19/WV-7 for approximately 1.7 miles. Turn left on WV-7 and continue on route for approximately 4.0 miles. The Boggess Pad Access Road Entrance will be on the right.

**From Blacksville**, take WV-7 E/Mason Dixon Highway for approximately 10.1 miles. The Boggess Pad Access Road Entrance will be on the left.

\*See Attached Maps

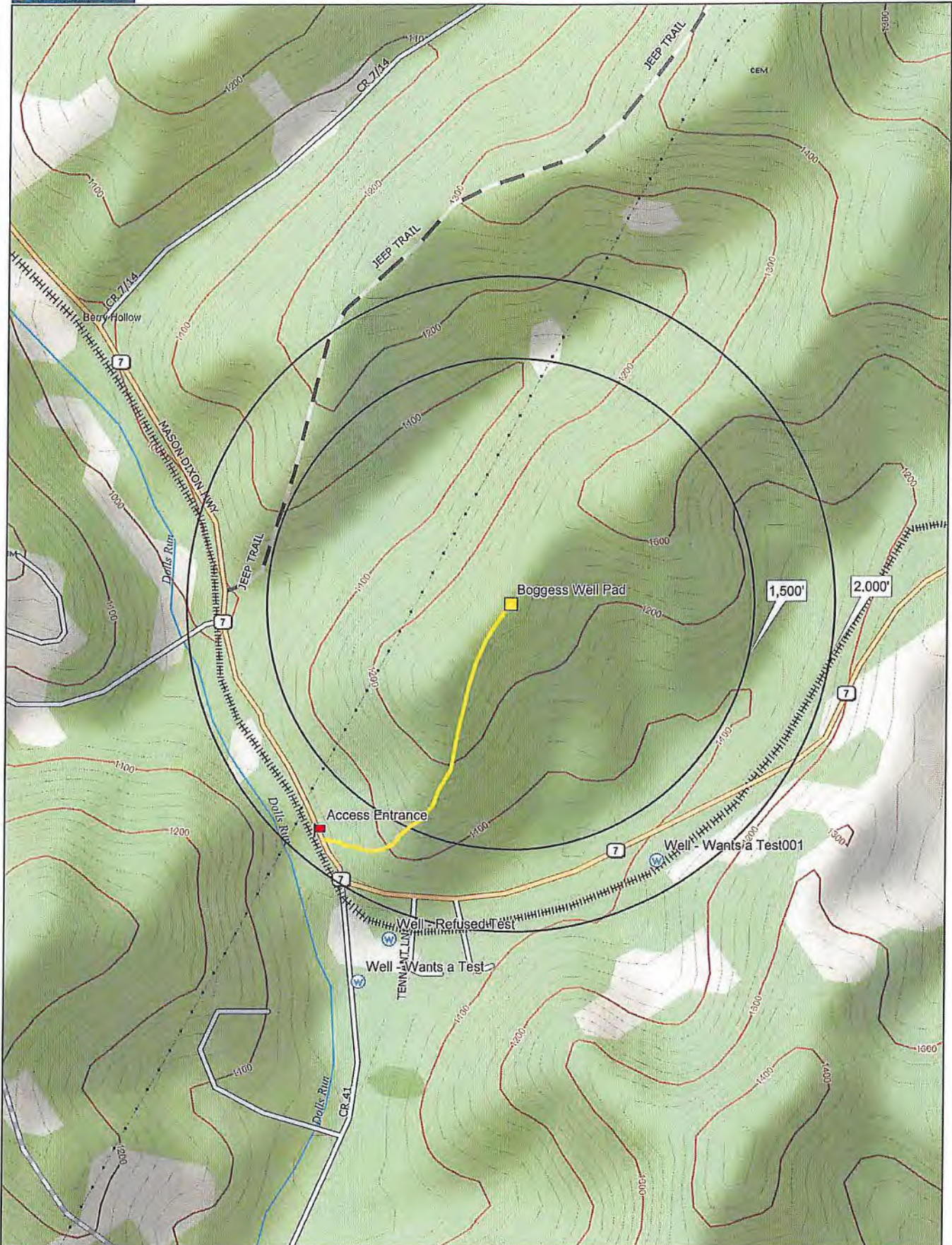

Data use subject to license.

© DeLorme. XMap® 7.

www.delorme.com

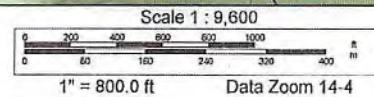

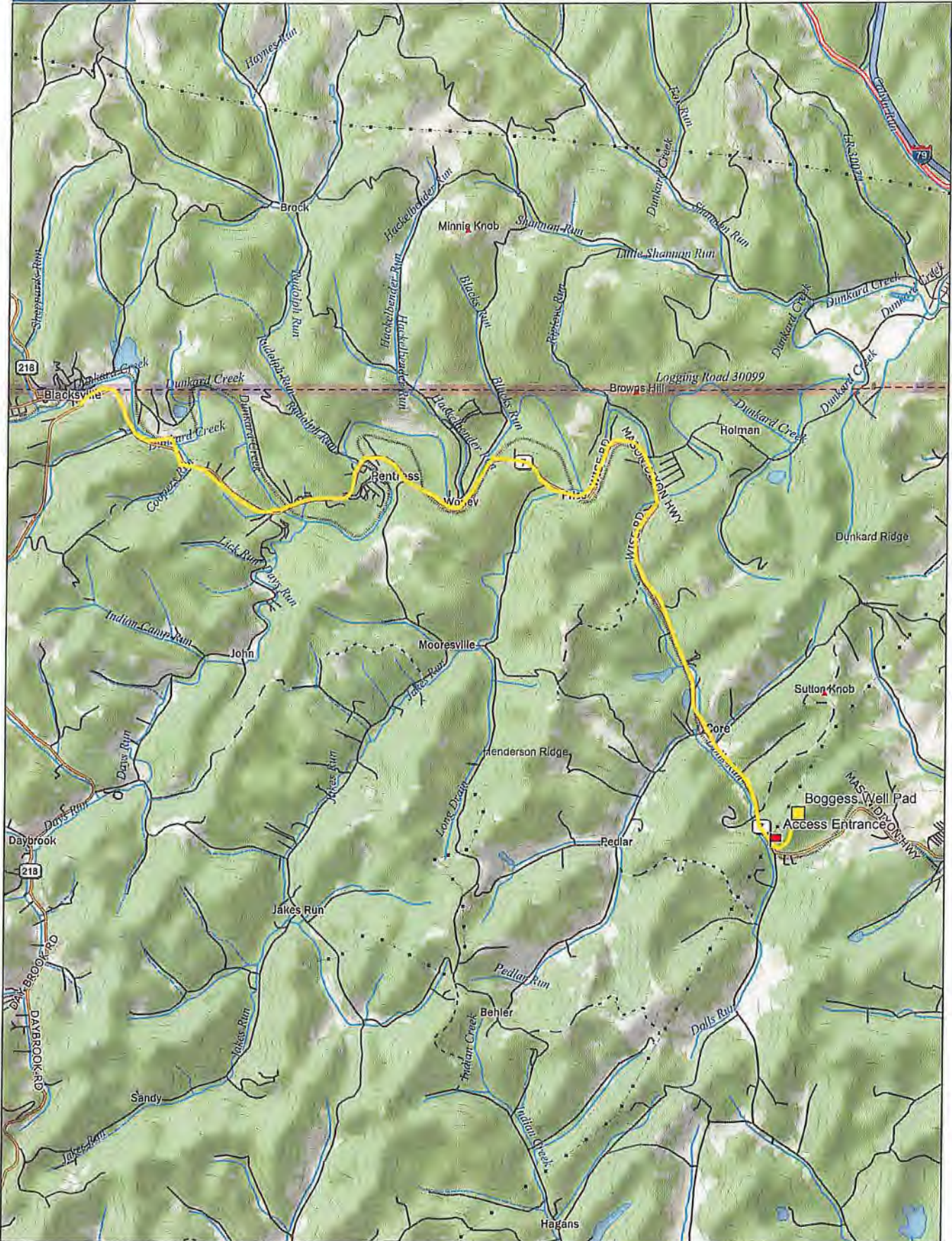

Data use subject to license.

© DeLorme. XMap® 7.

www.delorme.com



Scale 1 : 68,750

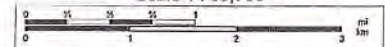

1" = 1.09 mi

Data Zoom 11-5

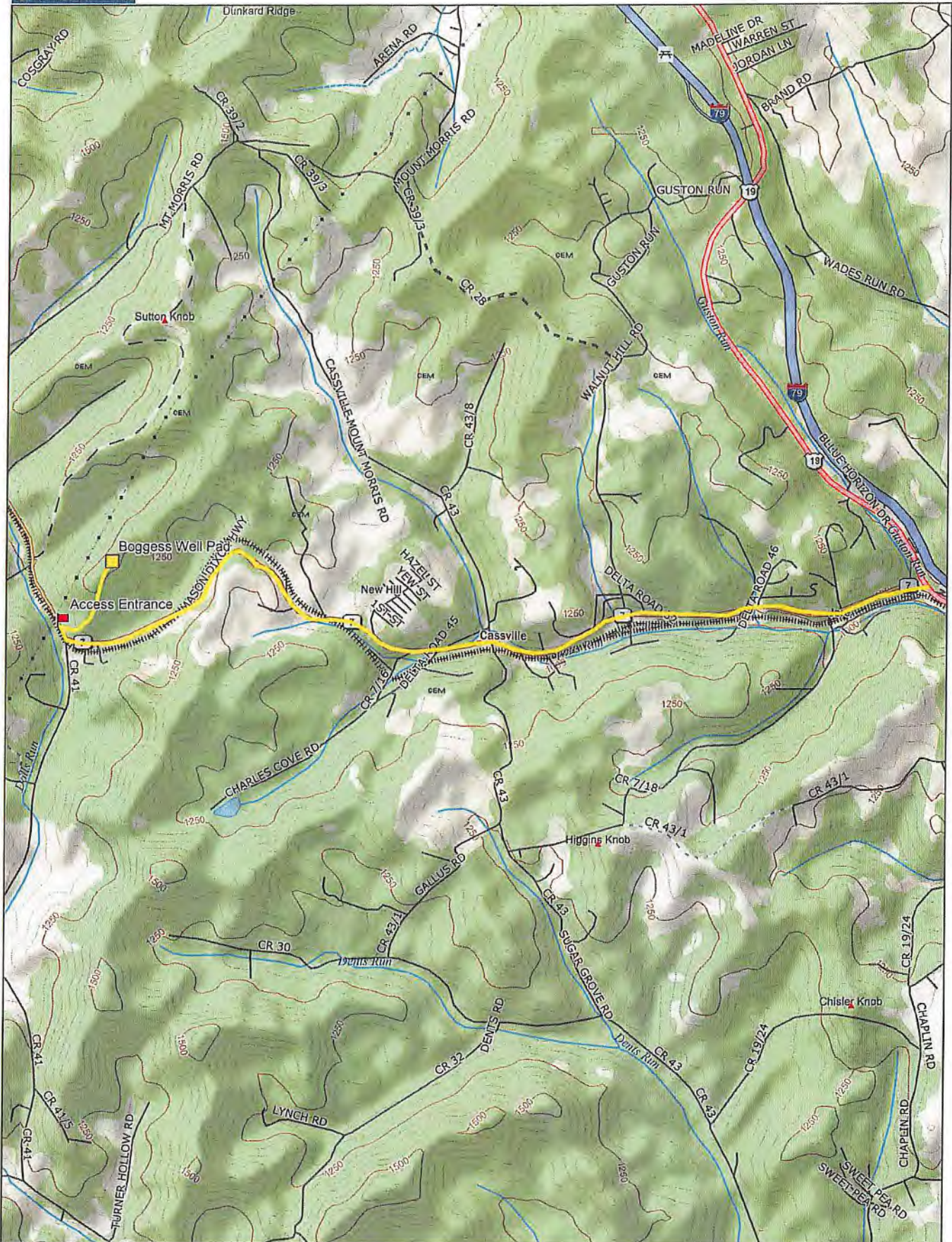

Data use subject to license.  
 © DeLorme. XMap® 7.  
 www.delorme.com

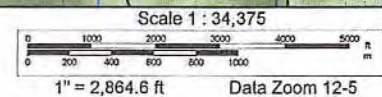
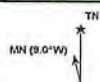

## **Introduction**

Northeast Natural Energy LLC (“NNE”) is an oil and gas exploration and production company with company headquarters located at the following address:

Northeast Natural Energy LLC  
707 Virginia Street East, Suite 1200  
Charleston, WV 25301

And a Field Operations Office located at the following address:

Northeast Natural Energy LLC  
48 Donley Street, Suite 601  
Morgantown, WV 26501

NNE is committed to protecting the people, property, and resources of the company and of the communities in which it works by establishing a safe and healthy work environment that is free from recognized hazards and complies with all local, state and federal regulations.

This Plan will be reviewed annually and may be subject to revision and/or update whenever any of the following occur:

- An incident occurs.
- A new chemical or process is utilized onsite.
- Existing processes are modified significantly.
- Regulations are revised significantly.
- The current Plan fails in an emergency situation.
- Changes in emergency response equipment occur.
- Changes in internal and external emergency resources occur.

**TABLE OF CONTENTS**

**1 – Contacts, Schedules and Meetings**

**2 – Maps and Diagrams**

**3 – Well Work**

**4 – Chemical Inventory & MSDS**

**5 – BOP and Well Control**

**6 – Hydrogen Sulfide (H<sub>2</sub>S)**

**7 – Flaring**

**8 – Collision Avoidance Safeguards, Practices and Standards**



# 1

# **Contacts, Schedules and Meetings**

**A. NORTHEAST NATURAL ENERGY LLC CONTACTS:**

24 hour emergency number 1-866-207-1846

**Construction/Reclamation**

- Mike Shreve – Construction Foreman 304.918.3050
- Dave McDougal – Manager of Civil Engineering 304.941.5033
- Brett Loflin – VP of Regulatory Affairs 304.414.7063

**Drilling/Completion**

- Jay Hewitt – Drilling Manager 304.382.1825
- Criss VanGilder – Completions Manager 405.757.8725
- Diane Corwin – General Manager – Operations 304.216.9959

**Production**

- John Landis - Production Manager 304.216.6854
- Diane Corwin – General Manager – Operations 304.216.9959

**B. EMERGENCY CONTACTS :**In the case of an emergency call **911****1. OPERATOR CONTACTS**

- 24 hour emergency number 1-866-207-1846

**2. DRILLING CONTRACTORS**

- Highlands –Vertical Drilling 304.389.5868
- Patterson Drilling – Horizontal Drilling 724.239.2812

**KEY CONTRACTORS AND VENDORS**

- Baker Hughes – Cement/Pumping 724.743.9208
- Halliburton – Cement/Pumping 888.223.4255
- Schlumberger – Logging/Cement 724.820.3360

**3. WV DEP/ OFFICE OF OIL AND GAS**

Pollution and Emergency Spills 1-800-642-3074

- James Martin – Chief 304.926.0499 Ext. 1654
- Gayne Knitoswski – Inspector 304.546.8171
- Joe McCourt– WV DEP Northern Inspector Supervisor 304.380.2467

**OFFICE OF AIR QUALITY**

- Kirk Powroznik – Inspector 304.368.3910
- Karl Dettinger – Inspector 304.368.3910

**4. LOCAL EMERGENCY RESPONSE UNITS****MONONGALIA COUNTY OFFICE OF EMERGENCY MANAGEMENT**

- 24 Hour Emergency Number 304.599.6382
- Jimmy Smith – Director 304.598.0301
- Harold Sperringer – Deputy Director

**FIRE DEPARTMENTS**

- Blacksville Volunteer 304.432.8282

**AMBULANCE / EMS**

- MON EMS 304.599.0650
- JAN-CARE 304.296.9700

**LIFE FLIGHT AMBULANCE SERVICE (HELICOPTER)**

- Angel MedFlight 866.604.8307

**STATE POLICE**

- Morgantown Detachment 304.285.3200

**COUNTY POLICE**

- Monongalia Sheriff 304.291.7290

**5. LOCAL ER PERSONNEL****HOSPITAL**

- Ruby Memorial (trauma 1) 304.598.4000
- Monongalia General (trauma 4) 304.598.1200



NOTE: SEE SHEET 2 FOR LEGEND. DATA WAS BASED UPON MONONGALIA COUNTY TAX MAPPING, ASSESSOR'S AND SHERIFF'S OFFICE RECORDS.

SCALE: 1" = 500' FT

Structure	Type	Owner	Street Address	City/Zip	Tax Map	Parcel
1	Golf Course	Ayers and Ayers Holdings	PO Box 1310	Inwood, WV 25428	11	44
2	Mining Training Site	WVU Board of Governors	2870 Little Indian Creek Road	Morgantown, WV 26501	15	40
3	Business	Poffenberger Family Trust	1929 Mason Dixon Highway	Maidsville, WV 26541	12	29.2
4	Residence/Private Structure	Roy Eddy	1435 Mason Dixon Highway	Maidsville, WV 26541	13	1
5	Residence/Private Structure	Roy Eddy	1445 Mason Dixon Highway	Maidsville, WV 26541	14	2
6	Residence/Private Structure	Betty Wiley	1519 Mason Dixon Highway	Maidsville, WV 26541	14	1
7	Residence/Private Structure	Chad Forman	1543 Mason Dixon Highway	Maidsville, WV 26541	15	28
8	Residence/Private Structure	Donald Masters	1557 Mason Dixon Highway	Maidsville, WV 26541	12	66
9	Residence/Private Structure	Marilyn Corbin	1581 Mason Dixon Highway	Maidsville, WV 26541	15	27.1
10	Residence/Private Structure	Blake Boggess	1584 Mason Dixon Highway	Maidsville, WV 26541	12	65
11	Residence/Private Structure	Blake Boggess	1596 Mason Dixon Highway	Maidsville, WV 26541	12	65
12	Residence/Private Structure	David Fox	1605 Mason Dixon Highway	Maidsville, WV 26541	15	27
13	Residence/Private Structure	Blake Boggess	1596 Mason Dixon Highway	Maidsville, WV 26541	15	65
14	Residence/Private Structure	Brittany Swanson	1643 Mason Dixon Highway	Maidsville, WV 26541	15	29.1
15	Residence/Private Structure	Donald Tennant	49 Tennant Lane	Maidsville, WV 26541	15	30.2
16	Residence/Private Structure	Donald Tennant	49 Tennant Lane	Maidsville, WV 26541	15	30.2
17	Residence/Private Structure	Donald Tennant	49 Tennant Lane	Maidsville, WV 26541	15	30.2
18	Residence/Private Structure	Thomas Hellyer	1681 Mason Dixon Highway	Maidsville, WV 26541	15	30.1
19	Residence/Private Structure	Mary Jane Walls	1685 Mason Dixon Highway	Maidsville, WV 26541	15	30.6
20	Residence/Private Structure	Denna Jones	1687 Mason Dixon Highway	Maidsville, WV 26541	15	30.9
21	Residence/Private Structure	Tyler Elliot	3120 Little Indian Creek Road	Maidsville, WV 26541	15	30.8
22	Residence/Private Structure	Laurie Cozort	30 Tennant Lane	Maidsville, WV 26541	15	30.4
23	Residence/Private Structure	Dave Jones	3106 Little Indian Creek Road	Maidsville, WV 26541	15	30.5
24	Residence/Private Structure	Timothy Lining	3090 Little Indian Creek Road	Maidsville, WV 26541	15	31
25	Residence/Private Structure	Danny Tennant	1709 Mason Dixon Highway	Maidsville, WV 26541	15	26
26	Residence/Private Structure	Blake Boggess	1596 Mason Dixon Highway	Maidsville, WV 26541	12	65
27	Residence/Private Structure	Darlene Klubeck	537 Pedlar Run Road	Maidsville, WV 26541	15	25
28	Residence/Private Structure	Darlene Klubeck	1813 Mason Dixon Highway	Maidsville, WV 26541	15	25
29	Residence/Private Structure	Billy Poffenberger	1830 Mason Dixon Highway	Maidsville, WV 26541	12	29.1
30	Residence/Private Structure	Billy Poffenberger	1840 Mason Dixon Highway	Maidsville, WV 26541	12	29.1
31	Residence/Private Structure	Billy Poffenberger	1859 Mason Dixon Highway	Maidsville, WV 26541	12	29
32	Residence/Private Structure	Danny Tennant	345 Danny T Lane	Maidsville, WV 26541	12	29.4
33	Residence/Private Structure	Billy Poffenberger	1859 Mason Dixon Highway	Maidsville, WV 26541	12	29

SUBSETUOUS-001-0004-1111-111111

CLIENT <b>NORTHEAST NATURAL ENERGY LLC</b>	PROJECT <b>BOGCESS WELL PAD</b>
DATE <b>1438008 PROJECT NO.</b>	CHECKED BY <b>DIEFFENBAUGH &amp; HRITZ</b>
DATE <b>1438008 PROJECT NO.</b>	APPROVED BY <b>MORGANTOWN, WV</b>
TITLE <b>BOGCESS RADIUS PLAN</b>	SHEET NO. <b>2</b>

Structure	Type	Owner	Street Address	City/Zip		District	Tax Map	Parcel
1	Golf Course	Ayers and Ayers Holdings	PO Box 1310	Inwood, WV 25428	304-328-5451	Cass	11	44
2	Mining Training Site	WVU Board of Governors	2870 Little Indian Creek Road	Morgantown, WV 26501	No listed phone number	Clay	15	40
3	Business	Poffenberger Family Trust: Charlene Frances Horan	1929 Mason Dixon Highway	Maidsville, WV 26541	304-879-5020	Clay	12	29.2
29,30	Residence/Private Structure	Billy Poffenberger: Poffenberger Family Revocable Living Trust	117 Forest Drive	Morgantown, WV 26505	304-879-5368/304-599-9533	Clay	12	29.1
31,33	Residence/Private Structure	Billy Poffenberger: Poffenberger Family Revocable Living Trust	117 Forest Drive	Morgantown, WV 26505	304-879-5368/304-599-9533	Clay	12	29
4,5	Residence/Private Structure	Roy Eddy	297 Stull Road	Maidsville, WV 26541	304-879-5362	Clay	13,14	1,2
6	Residence/Private Structure	Betty Wiley	373 Dunkard Avenue	Morgantown, WV 26501	304-292-3946	Clay	14	1
7	Residence/Private Structure	Chad Forman	1543 Mason Dixon Highway	Core, WV 26541	304-708-0129	Clay	15	28
8	Residence/Private Structure	Donald Masters	1557 Mason Dixon Highway	Maidsville, WV 26541	304-879-5225: 304-594-3166	Clay	12	66
9	Residence/Private Structure	Marilyn Corbin	1581 Mason Dixon Highway/P.O. Box 278	Maidsville, WV 26541	No listed phone number	Clay	15	27.1
10,11,13,26	Residence/Private Structure	Blake Boggess	1584 Mason Dixon Highway	Maidsville, WV 26541	304-879-5379	Clay	12	65
12	Residence/Private Structure	David Fox	1605 Mason Dixon Highway	Maidsville, WV 26541	No listed phone number	Clay	15	27
14	Residence/Private Structure	Brittany Swanson	1643 Mason Dixon Highway	Maidsville, WV 26541	No listed phone number	Clay	15	29.1
15,16,17	Residence/Private Structure	Donald & Nellie Marlene Tennant	37 Tennant Lane	Maidsville, WV 26541	304-983-8262	Clay	15	30.2
18	Residence/Private Structure	Thomas Hellyer	1681 Mason Dixon Highway	Maidsville, WV 26541	304-879-5775	Clay	15	30.1
19	Residence/Private Structure	Mary Jane Walls	3230 Mason Dixon Highway	Maidsville, WV 26541	304-879-5231	Clay	15	30.6
20	Residence/Private Structure	Donna Sue and David Jones	3106 Little Indian Creek Road	Core, WV 26541	304-983-2159	Clay	15	30.9
21	Residence/Private Structure	Tyler Elliot and Katherine Brewer	3120 Little Indian Creek Road	Maidsville, WV 26541	304-879-5477	Clay	15	30.8
22	Residence/Private Structure	Laurie Cozort	30 Tennant Lane	Core, WV 26541	No listed phone number	Clay	15	30.4
23	Residence/Private Structure	Dave and Donna Sue Jones	3106 Little Indian Creek Road	Maidsville, WV 26541	304-983-2159	Clay	15	30.5
24	Residence/Private Structure	Timothy Liming	3090 Little Indian Creek Road	Maidsville, WV 26541	304-879-5591	Clay	15	31
25	Residence/Private Structure	Danny & Deanna Tennant	345 Danny T Lane	Core, WV 26541	304-879-5199	Clay	15	26
27,28	Residence/Private Structure	Darlene Klubeck	537 Pedlar Run Road	Maidsville, WV 26541	No listed phone number	Clay	15	25
32	Residence/Private Structure	Danny & Deanna S. Tennant	345 Danny T Lane	Maidsville, WV 26541	304-879-5199	Clay	12	29.4

**C. NOTIFICATION OF H<sub>2</sub>S GAS PRESENCE**

Detection of H<sub>2</sub>S shall sound an alarm which notifies personnel to shut in the well(s) and evacuate to the predetermined safe zone immediately.

A wind sock and/or flags will be utilized on location to identify wind direction. A safe zone upwind and away from the well will be established at the beginning of each tour. Personnel are trained to evacuate the well and gather at this safe zone immediately at the first sound of an H<sub>2</sub>S explosive gas alarm.

When in a historically known area, or after H<sub>2</sub>S is first detected, operations will halt, evacuation procedures will be followed, and all personnel will be trained for detailed H<sub>2</sub>S protocols before operations begin or resume.

After personnel are located in a safe area, the onsite supervisor will take a head count, and make the proper offsite notifications. The DEP Office of Oil and Gas will be notified by a phone call to both the local inspector and the emergency number. The local emergency responders may also be notified of the detection.

In the event that H<sub>2</sub>S has been detected, the onsite supervisor shall use his discretion as to the severity of the event and whether the local community should be notified. NNE will make a diligent effort to identify local residents and businesses within a ½ mile radius of its unconventional well sites (\*see attached). Notification of such residence may be done in the form of a phone call or a door to door visit. NNE also recognizes that in most emergency situations the local emergency responders will coordinate any notification or evacuation procedures for the community and NNE will work closely with such emergency responders in their efforts.

**D. PRE-SPUD MEETINGS**

Prior to drilling operations, an onsite "Pre-Spud" meeting will be held to address operations and the site safety plan. This meeting shall include the overseeing NNE Drilling/Completions Engineer, the staff or contracted site supervisor(s) ("Company Man"), any staff or contracted safety personnel, key contractors to the drilling process, the contracted rig's superintendent/tool pusher, and the local oil and gas inspector if available. Local emergency response personnel may also be invited to the pre-spud meeting. The regional DEP inspector will be notified 48-hours in advance of the meeting. All attending personnel will be documented. Contractors will be provided copy of and instructed to go over the site safety plan with their respective individual employees.

**E. WELL SITE SAFETY MEETINGS**

Safety Meetings will be held on-site, at a minimum, on a weekly basis and prior to the beginning of drilling, completion and work-over operations. Attendance at each safety meeting will be logged.

Additionally, as a means of safety and maintaining a head count in case of an incident, a check-in and check-out list of both personnel and visitors will be kept during all drilling, completion, and work over phases of operation. The rig/frac supervisor will be responsible for the checking in and out of all personnel on location. A sign will be posted at the entrance to the location directing all visitors to the company trailer.



# 2

# Maps and Diagrams

- NOTES:
1. TOPOGRAPHIC INFORMATION OBTAINED FROM LIDAR (DATUM NAD 83 WYD, NAVD 88)
  2. PROPERTY LINE INFORMATION OBTAINED FROM TAX MAPS AND SHOULD BE USED AS REFERENCE ONLY.
  3. THE PROPERTIES AFFECTED BY THIS DEVELOPMENT ARE LOCATED ON FIRM MAP NUMBER A001 DATED (1-20-2018). THE LIMITS OF DISTURBANCE PROPOSED WITH THIS DEVELOPMENT IS LOCATED IN ZONE (A) AS DEFINED BY THE FIRM.
  4. RECEIVING STREAMS: (S) UNIT TO DOLLS RUN
  5. PROPOSED CUT AND FILL SLOPES ARE TO BE GRADED AT 2:1 UNLESS OTHERWISE NOTED.
  6. PLACE EROSION CONTROL BLANKETS ON ALL SLOPES X1 AND STEPPERS.
  7. LIMITS OF DISTURBANCE: 20.18 AC.
  8. PLACE ROCK CHECK DAMS IN ALL DITCHES PER DETAIL 1, ON SHEET 12.
  9. SAFETY BERMS ARE TO BE INSTALLED AND REMAIN IN PLACE TO PROVIDE TOTAL CONTAINMENT THROUGHOUT ALL DRILLING AND COMPLETION OPERATIONS.

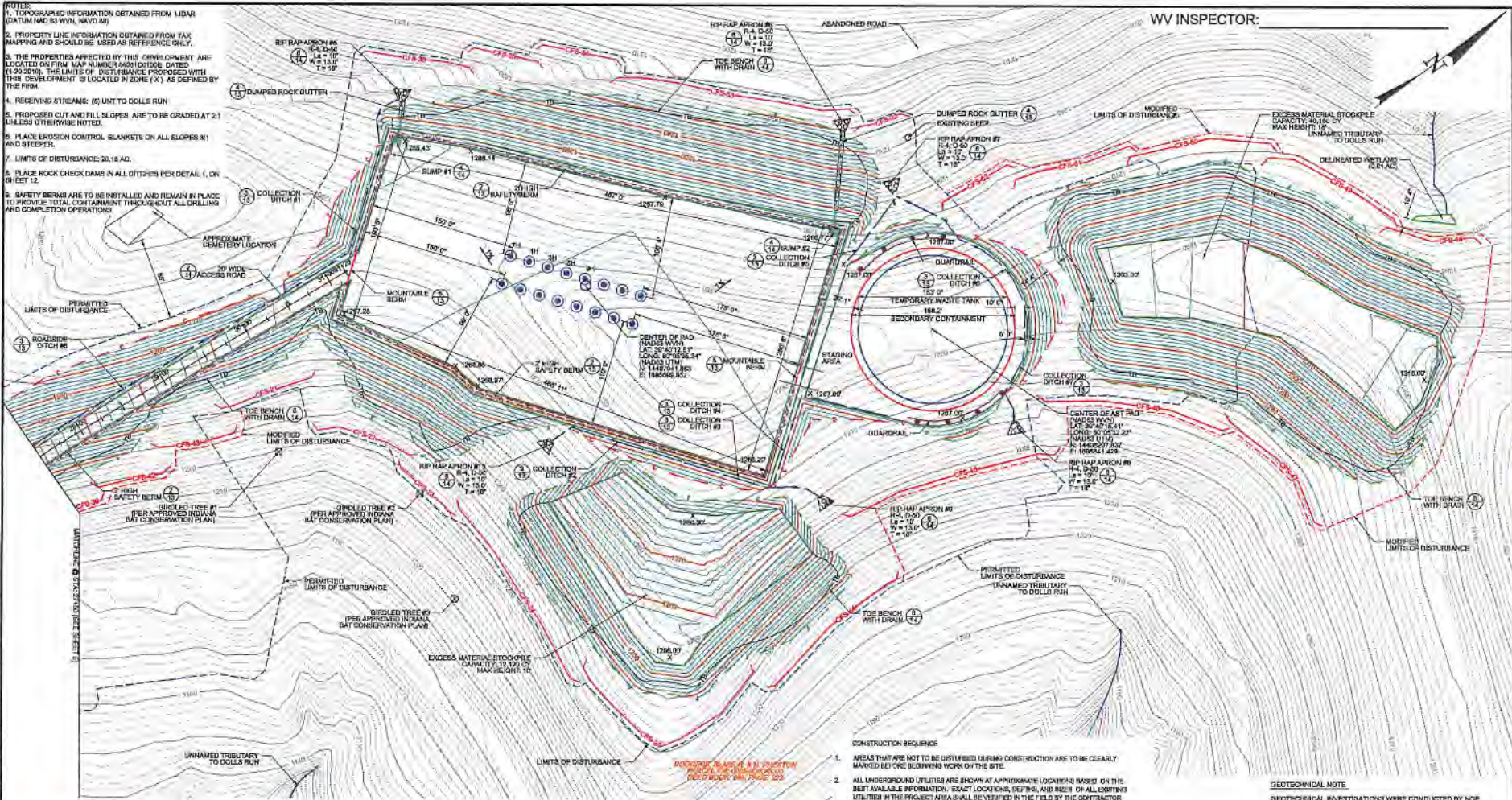

WV INSPECTOR:

**LEGEND**

EXISTING TREE LINE	EXISTING INDEX CONTOUR LINE (10')
EXISTING ROAD	EXISTING INTERMEDIATE CONTOUR LINE
EXISTING RIGHT-OF-WAY	PROPOSED INDEX CONTOUR LINE (10')
PROPOSED RIGHT-OF-WAY	PROPOSED INTERMEDIATE CONTOUR LINE
PROPERTY LINE	CHANNEL FLOW DIRECTION
MUNICIPAL BOUNDARY	STREAM
PROPOSED FENCE	DELIMITATED WETLAND
EXISTING FENCE	DELIMITATED WETLAND BOUNDARY
EXISTING ELECTRIC LINE	FLOODWAY BOUNDARY
EXISTING GAS LINE	RIP-RAP BUFFER
PROPOSED GAS LINE	PERMITTED COMPOST FILTER BLOCK (CFS)
PROPOSED WATER LINE	PERMITTED TRIPLE CFS RTACK
FILL LIMITS	MODIFIED COMPOST FILTER BLOCK (CFS)
CUT LIMITS	MODIFIED TRIPLE CFS STACK
TOE BENCH WITH DRAIN	CFS SEDIMENT TRAP
ROADWAY CENTERLINE	EXISTING SPOT ELEVATION
SAFETY BERM	PROPOSED SPOT ELEVATION
PERMITTED LIMITS OF DISTURBANCE	EXISTING STRUCTURE
MODIFIED LIMITS OF DISTURBANCE	
EXISTING UTILITY POLE	

**WELL HEAD COORDINATES**

WELL SLOT 7H (NAD83)	Easting: 38' 46' 12.31"	Northing: 90' 09' 36.09"
WELL SLOT 7H (NAD83)	Easting: 38' 46' 12.31"	Northing: 90' 09' 36.09"
WELL SLOT 7H (NAD83)	Easting: 38' 46' 12.31"	Northing: 90' 09' 36.09"
WELL SLOT 7H (NAD83)	Easting: 38' 46' 12.31"	Northing: 90' 09' 36.09"
WELL SLOT 7H (NAD83)	Easting: 38' 46' 12.31"	Northing: 90' 09' 36.09"

**TEMPORARY WASTE TANK CAPACITY**

TOTAL STORAGE VOLUME	= 46,000 BBL'S
STORAGE VOLUME WITH	= 33,791 BBL'S
Z OF FREEDOM	

**PARTIAL WORK SUMMARY (WITH LAST PAD)**

TOTAL RAW PAD CUT	= 54,929 CY
TOTAL RAW ROAD CUT	= 21,480 CY
TOTAL RAW CUT	= 76,418 CY
TOTAL SWELLED CUT	= 34,980 CY
TOTAL FILL	= 32,018 CY
TOTAL TOPSOIL	= 11,291 CY
** ASSUMED 10% SWELL	
** ASSUMED 10' DEPTH FOR TOPSOIL	

**LIMITS OF DISTURBANCE SUMMARY**

PERMITTED LIMITS OF DISTURBANCE	= 19.89 AC
MODIFIED LIMITS OF DISTURBANCE	= 20.18 AC
DIFFERENCE IN LIMITS OF DISTURBANCE	= 0.29 AC

- CONSTRUCTION SEQUENCE**
1. AREAS THAT ARE NOT TO BE DISTURBED DURING CONSTRUCTION ARE TO BE CLEARLY MARKED BEFORE BEGINNING WORK ON THE SITE.
  2. ALL UNDERGROUND UTILITIES ARE SHOWN AT APPROXIMATE LOCATIONS BASED ON THE BEST AVAILABLE INFORMATION. EXACT LOCATIONS, DEPTHS AND TYPES OF ALL UTILITIES UTILIZED IN THE PROJECT AREA SHALL BE VERIFIED IN THE FIELD BY THE CONTRACTOR WITH A REPRESENTATIVE FROM THE APPROPRIATE UTILITY COMPANY. THE CONTRACTOR SHALL BE RESPONSIBLE FOR NOTIFYING ALL UTILITY COMPANIES AT LEAST SEVENTY-TWO (72) HOURS BEFORE ANY WORK IS COMMENCED ON THIS PROJECT.
  3. EROSION AND SEDIMENT CONTROL DEVICES, AS REQUIRED BY THE EROSION AND SEDIMENT CONTROL PLAN AND DICTATED BY FIELD CONDITIONS, ARE TO BE INSTALLED PRIOR TO CONDUCTING ANY CONSTRUCTION ACTIVITY ON THE SITE.
  4. CONSTRUCTION ACTIVITY WILL BEGIN WITH THE CLEARING AND GRUBBING OF THE ACCESS ROAD FROM THE SITE POINT OF ACCESS TO THE DRILL PAD AND PIT LOCATIONS.
  5. TEMPORARY AND/OR PERMANENT SEEDING AND MULCHING SHALL FOLLOW EARTHMOVING ACTIVITY AS CLOSELY AS POSSIBLE AND SHOULD BE STABILIZED WITHIN 4 DAYS OF ANY CESSION OF EARTHMOVING ACTIVITIES.
  6. THE REMAINING PROJECT AREA WILL THEN BE CONSTRUCTED AND GRUBBED FOLLOWING INSTALLATION OF THE EROSION & SEDIMENT CONTROL DEVICES AT THE DRILL PAD AND PIT LOCATIONS.
  7. THE DRILL PAD AND AST PAD LOCATIONS WILL THEN BE CONSTRUCTED. FINAL GRADING COMPLETED, GRAVES WILL BE PLACED ON THE PAD AREA AND ACCESS ROAD AND SOIL AREAS WILL BE FERTILIZED AND PERMANENTLY SEEDS AND MULCHED.
  8. FOLLOWING COMPLETION OF OPERATIONS, THE GRADES, PAD SURFACE WILL BE REMOVED, SOIL WILL BE SCATTERED, TOPSOIL REPLACED AND SEEDS.
  9. TEMPORARY EROSION CONTROLS SHALL REMAIN IN PLACE UNTIL A UNIFORM TO PERCENT VEGETATIVE COVER IS ESTABLISHED.

- GEOTECHNICAL NOTE**
- GEOTECHNICAL INVESTIGATIONS WERE CONDUCTED BY NGE, LLC AS PART OF THE SITE DESIGN. REFER TO NGE GEOTECHNICAL INVESTIGATION REPORT #W4898, DATED OCTOBER 2014, FOR DETAILED DATA. ADJUSTMENTS TO CUT AND FILL SLOPES SHOULD NOT BE MADE UNLESS REVIEWED BY NGE, LLC AND DIFFENBAUGH & HRTZ, LLC.
- COMPACTION SPECIFICATIONS**
1. SOIL FILL SHOULD BE PLACED IN MAXIMUM 12-INCH THICK LADGE LIFTS. EACH LIFT OF SOIL SHOULD BE COMPACTED TO AT LEAST 90% OF THE MAXIMUM DRY DENSITY AS DETERMINED BY THE STANDARD PROCTOR LABORATORY TEST ASTM D999. ALL SOIL FILL SHOULD BE MOISTURE CONDITION TO WITHIN THREE PERCENTAGE POINTS OF THE MATERIAL'S OPTIMUM MOISTURE CONTENT AS DETERMINED BY THE STANDARD PROCTOR TEST. COMPACTION OF CLAYEY SOIL FILL SHOULD BE ACCOMPLISHED USING A MINIMUM 10-TON STATIC WEIGHT SHEEPSFOOT ROLLER. COMPACTION OF GRANULAR FILL SHOULD BE PERFORMED USING A VIBRATORY STEEL DRUM ROLLER. A SUFFICIENT NUMBER OF FIELD MOISTURE DENSITY TESTS SHOULD BE PERFORMED ON EACH LIFT OF SOIL FILL TO VERIFY AND DOCUMENT THAT THE REQUIRED REL DENSITY IS ACHIEVED.
  2. EARTHEN FILLS SHALL NOT INCLUDE ANY FROZEN OR ORGANIC MATERIALS.

RESUME: 001-HA00-VY-V-K0000

NO. 1	DATE	DESCRIPTION	BY
1		ISSUED FOR CONSTRUCTION	
2		ISSUED FOR CONSTRUCTION	
3		ISSUED FOR CONSTRUCTION	
4		ISSUED FOR CONSTRUCTION	
5		ISSUED FOR CONSTRUCTION	
6		ISSUED FOR CONSTRUCTION	
7		ISSUED FOR CONSTRUCTION	
8		ISSUED FOR CONSTRUCTION	
9		ISSUED FOR CONSTRUCTION	
10		ISSUED FOR CONSTRUCTION	

DATE: JUNE 2015  
 DATE: 140608  
 PROJECT NO: 140608

DIFFENBAUGH & HRTZ  
 WASHINGTON, WV

NORTHEAST NATURAL ENERGY LLC

BOGGS WELL PAD MODIFICATION

SITE PLAN

6

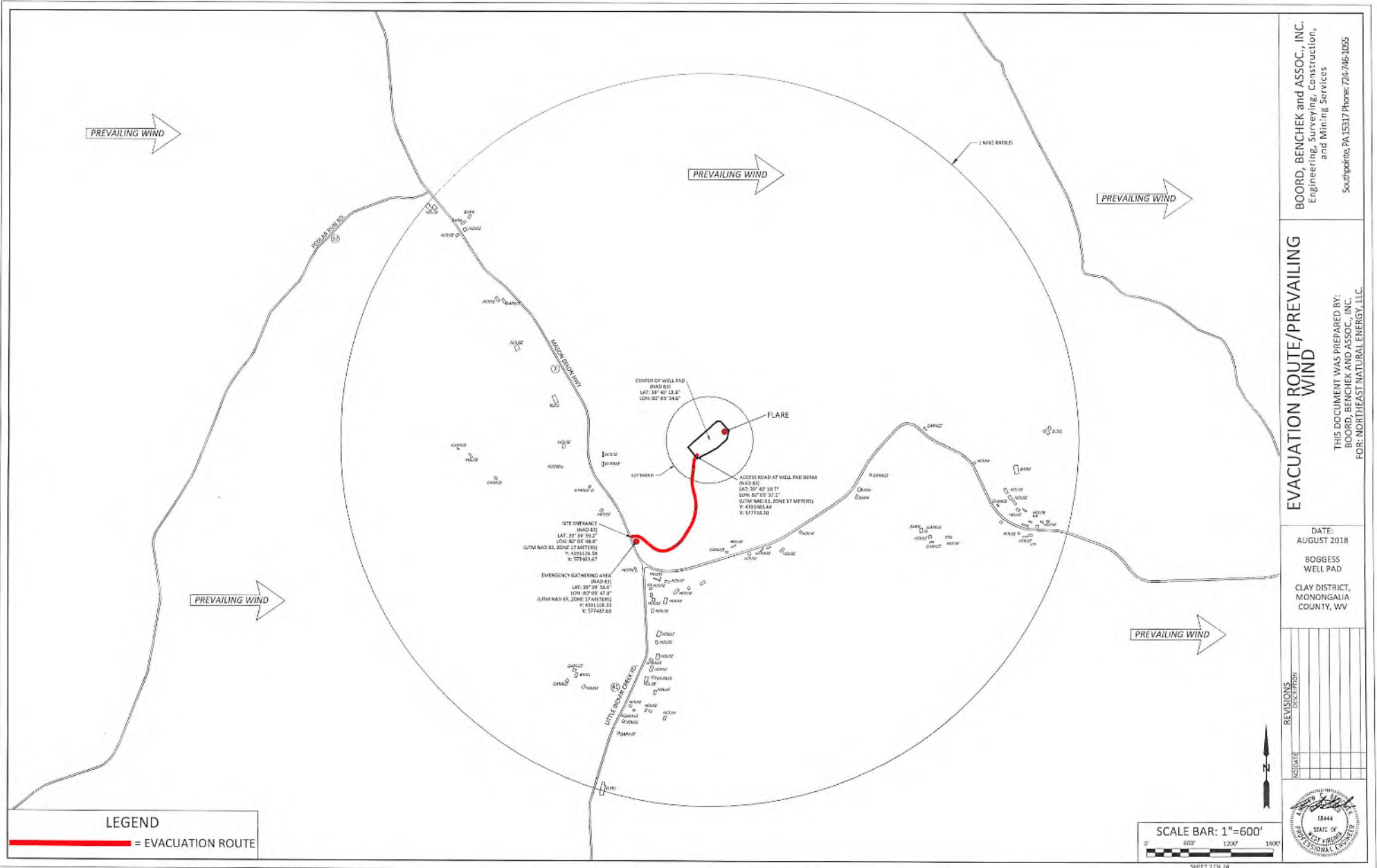

PREVAILING WIND

PREVAILING WIND

PREVAILING WIND

PREVAILING WIND

PREVAILING WIND

BOARD, BENCHEK and ASSOC., INC.  
Engineering, Surveying, Construction,  
and Mining Services  
Southpointe, PA 15317 Phone: 724-746-1055

**EVACUATION ROUTE/PREVAILING WIND**

THIS DOCUMENT WAS PREPARED BY:  
BOARD, BENCHEK and ASSOC., INC.  
FOR: NORTHEAST NATURAL ENERGY, LLC.

DATE:  
AUGUST 2018  
BOGGS  
WELL PAD  
CLAY DISTRICT,  
MONONGALIA  
COUNTY, WV

REVISIONS	DESCRIPTION



SCALE BAR: 1"=600'  
0' 600' 1200' 1800'

**LEGEND**  
— = EVACUATION ROUTE

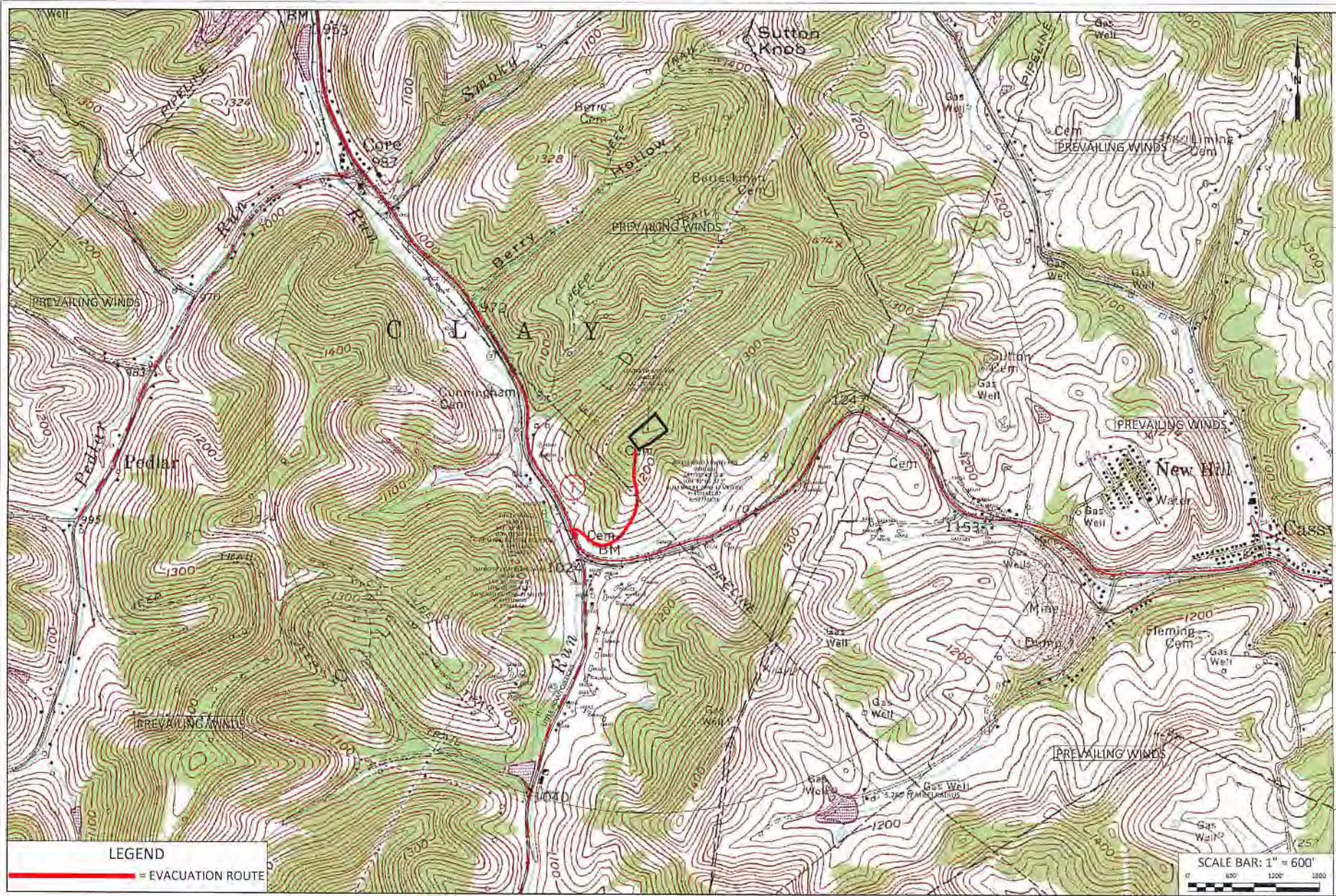

**LEGEND**  
——— = EVACUATION ROUTE

SCALE BAR: 1" = 600'  
 0' 600' 1200' 1800'

SHEET 2

**EVACUATION ROUTE/  
 PREVAILING WINDS**

JUNE 2015  
 BOGGS  
 WELL PAD  
 CLAY DISTRICT  
 MONONGALIA  
 COUNTY, WV

**BOORD, BENCHEK and ASSOC., INC.**  
 Engineering, Surveying, Construction,  
 and Mining Services  
 Southpointe, PA 15317 Phone: 724-745-0555

THIS DOCUMENT WAS PREPARED BY:  
 BOORD, BENCHEK AND ASSOC., INC.  
 FOR: NORTHEAST NATURAL ENERGY LLC



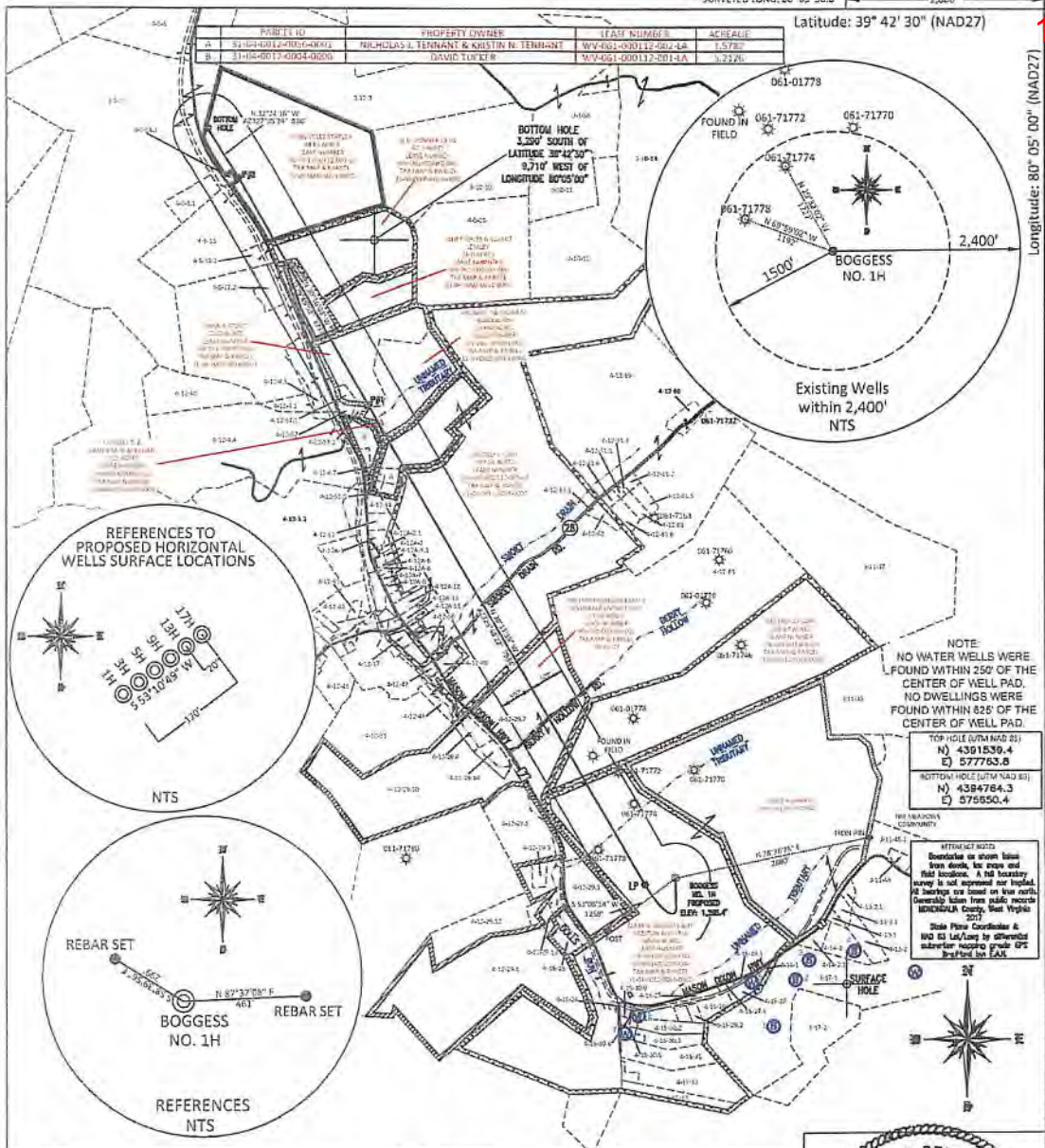

FILE #: NEE14  
 DRAWING #: 2862  
 SCALE: PLAT: 1" = 2000'  
 TICK MARKS: 1" = 2000'  
 MINIMUM DEGREE OF ACCURACY: 1/200  
 PROVEN SOURCE OF ELEVATION: SUBMETER MAPPING GRADE GPS

I, THE UNDERSIGNED, HEREBY CERTIFY THAT THIS PLAT IS CORRECT TO THE BEST OF MY KNOWLEDGE AND BELIEF AND SHOWS ALL THE INFORMATION REQUIRED BY LAW AND THE REGULATIONS ISSUED AND PRESCRIBED BY THE DEPARTMENT OF ENVIRONMENTAL PROTECTION.  
 Signed: *[Signature]*  
 L.L.S. #2124 : Ernest J. Benckek III

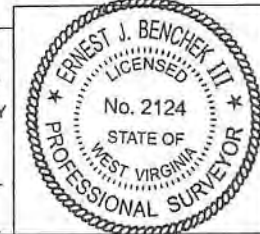

(+) DENOTES LOCATION OF WELL ON UNITED STATES TOPOGRAPHIC MAPS  
 WVDOP  
 OFFICE OF OIL & GAS  
 601 57TH STREET  
 CHARLESTON, WV 25304

DATE: September 26, 2018  
 OPERATOR'S WELL #: BOGCESS NO. 1H  
 API WELL #: 47 61 47-061-01811  
 STATE COUNTY PERMIT

Well Type:  Oil  Waste Diposal  Production  Deep  
 Gas  Liquid Injection  Storage  Shallow

WATERSHED: DUNKARD CREEK  
 COUNTY/DISTRICT: MONONGALIA / CLAY  
 SURFACE OWNER: BLAKE R. & PRESTON H. BOGCESS  
 OIL & GAS ROYALTY OWNER: BLAKE R. & PRESTON H. BOGCESS 'et al'  
 LEASE NUMBERS:

PROPOSED ELEVATION: 1,265.4'  
 QUADRANGLE: OSAGE, WV  
 ACREAGE: 389.96 +/-  
 ACREAGE: 1075.72 +/-

DRILL  CONVERT  DRILL DEEPER  REDRILL  FRACTURE OR STIMULATE   
 PLUG OFF FORMATION  PERFORATE NEW FORMATION  PLUG & ABANDON   
 CLEAN OUT & REPLUG  OTHER CHANGE  (SPECIFY):

TARGET FORMATION: MARCELLUS  
 ESTIMATED DEPTH: TVD: 8,074' TMD: 21,049'  
 WELL OPERATOR: NORTHEAST NATURAL ENERGY LLC  
 ADDRESS: 707 VIRGINIA STREET EAST, SUITE 1200  
 CITY: CHARLESTON STATE: WV ZIP CODE: 25301

DESIGNATED AGENT: JOHN ADAMS  
 ADDRESS: 707 VIRGINIA STREET EAST, SUITE 1200  
 CITY: CHARLESTON STATE: WV ZIP CODE: 25301

WELL NAME: BOGESS NO. 1H  
OSAGE, WV

12/21/2018



# NORTHEAST NATURAL ENERGY, LLC

Location: Monongalia County, WV  
 Field: Monongalia  
 Facility: Boggress Pad

Slot: Slot 01  
 Well: Boggress 1H  
 Wellbore: Boggress 1H PWB



Location Information					
Facility Name		Grid East (US ft)	Grid North (US ft)	Latitude	Longitude
Boggress Pad		1801481.600	426749.600	39°40'12.490"N	80°05'36.030"W
Slot	Local N (ft)	Local E (ft)	Grid East (US ft)	Grid North (US ft)	Latitude
Slot 01	-0.07	-0.13	1801481.470	426749.530	39°40'12.490"N
Ground Level (GL) to Ground level (At Slot: Slot 01)					0ft
Mean Sea Level to Ground level (At Slot: Slot 01)					-1268ft
Ground Level (GL) to Mean Sea Level					1268ft

Type	Hole Size	Casing Size	Grade		GL Depth (Csg)
Conductor	28"	24"	NA		40'
Surface	17-1/2"	13-3/8"	J-55	54.5	1260'
Intermediate	12-1/4"	9-5/8"	J-55	40	2500'

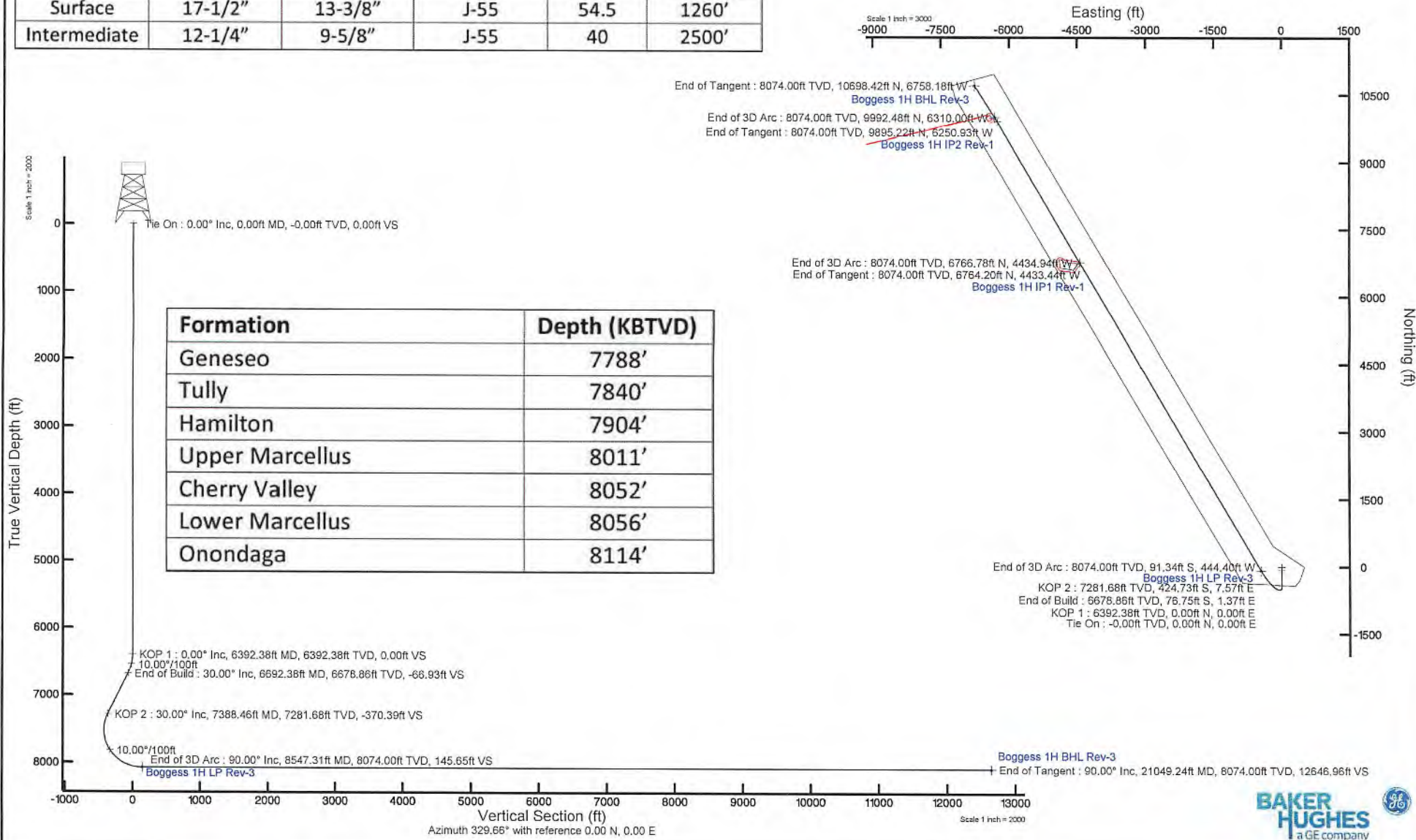

**3**

**Well Work**



**A(1.0) Description of Drilling Operations**

The Boggess 1H well will be drilled on air to an approximate depth of 6,714.18' TVD/MD. The well will then be horizontally drilled on synthetic based mud from the KOP to approximately 8,076.50' TVD / 20,242' MD along a 329° azimuth.

**A(1.1) Anticipated Equipment/Materials**

During the drilling of a horizontal Marcellus gas well the following equipment and materials could be on the drilling location:

<b>Equipment / Materials</b>	<b>Potential Hazard</b>
Double Stand Drilling Rig	Medical, Fire/Explosion, Spill/Release
Mud Pumps	Medical, Fire/Explosion, Spill/Release
Mud Tanks	Medical, Fire/Explosion, Spill/Release
Fork Lift	Medical, Fire/Explosion, Spill/Release
Excavator	Medical, Fire/Explosion, Spill/Release
Diesel Tank	Medical, Fire/Explosion, Spill/Release
Diesel Fuel	Medical, Fire/Explosion, Spill/Release
Generators	Medical, Fire/Explosion, Spill/Release
Air Compressor	Medical, Fire/Explosion
Light Tower	Medical, Fire/Explosion, Spill/Release
Frac Tanks (mud, cement additives,	Medical, Fire/Explosion, Spill/Release
Drilling Mud Additives	Medical, Fire/Explosion, Spill/Release

## **A(2.0) Description of Completions Operations**

The Boggess 1H well will be completed using a multi-stage / high-rate slickwater fracture treatment using sand as a proppant. The First Stage will be initiated via pressurization against a burst disc ran in the production casing string and perforated by pumping down guns on wireline. Subsequent stages will also be perforated with pumped down guns ran on wireline. Individual stages will be isolated with composite frac plugs. Maximum pump rate during any stage will be 110 BPM with a maximum allowable surface pressure of 9,500 PSI. Composite bridge plugs will be set at the end of the last stage to isolate the treated formation. After the fracture treatment, composite frac plugs will be drilled out using a service rig and/or snubbing unit.

### **A(2.1) Anticipated Equipment/Materials**

During the completion of a horizontal Marcellus gas well the following equipment and materials could be on the drilling location:

<b>Equipment / Materials</b>	<b>Potential Hazard</b>
Approximately 10 - 15 Pump Trucks	Medical, Fire/Explosion, Spill/Release
2 Blender Trucks	Medical, Fire/Explosion, Spill/Release
Belt Truck	Medical, Fire/Explosion, Spill/Release
Perforation Truck	Medical, Fire/Explosion, Spill/Release
Crane	Medical, Fire/Explosion, Spill/Release
Sand Tanks	Medical, Fire/Explosion, Spill/Release
Frac Tanks	Medical, Fire/Explosion, Spill/Release
Man Lift	Medical, Fire/Explosion, Spill/Release
Acid Truck	Medical, Fire/Explosion, Spill/Release
Fork Lift	Medical, Fire/Explosion, Spill/Release

Gel Truck	Medical, Fire/Explosion, Spill/Release
Communications Truck	Medical, Fire/Explosion, Spill/Release
Diesel Truck	Medical, Fire/Explosion, Spill/Release
Diesel Fuel	
80/90 wt gear oil	Medical, Fire/Explosion, Spill/Release
5/40 motor oil	Medical, Fire/Explosion, Spill/Release
Antifreeze	Medical, Fire/Explosion, Spill/Release
Ethylene Glycol	Medical, Fire/Explosion, Spill/Release
Tri-Ethylene Glycol	Medical, Fire/Explosion, Spill/Release
Frac Sand	Medical, Fire/Explosion, Spill/Release
Hydrochloric Acid (HCl)	Medical, Fire/Explosion, Spill/Release
Friction Reducer	Medical, Fire/Explosion, Spill/Release
Gelling Agents	Medical, Fire/Explosion, Spill/Release
Biocide	Medical, Fire/Explosion, Spill/Release
Scale Inhibitor	Medical, Fire/Explosion, Spill/Release
Iron Control	Medical, Fire/Explosion, Spill/Release
Gel Breaker Agent	Medical, Fire/Explosion, Spill/Release
Corrosion Inhibitor	Medical, Fire/Explosion, Spill/Release

**A(3.0) Description of Production Operations**

During the production phase, the well stream will flow through buried, welded piping to Gas Production Units. At this point, the gas will be separated from the water and sent through a meter to a sales pipeline. The water will be piped and stored in above ground tanks on the well site. Well pressures and flow rates will be monitored and recorded to ensure proper facility operation. All facilities will be installed according to industry standards and will have appropriate safety systems in place.

**A(3.1) Anticipated Equipment/Materials****Production**

<b>Equipment / Materials</b>	<b>Potential Hazard</b>
Well Head	Medical, Fire/Explosion, Spill/Release
Buried Flow Line	Medical, Fire/Explosion, Spill/Release
Sand Separator	Medical, Fire/Explosion, Spill/Release
Gas Processing Unit	Medical, Fire/Explosion, Spill/Release
Water Tanks	Medical, Fire/Explosion, Spill/Release
Condensate Tank	Medical, Fire/Explosion, Spill/Release
Water Truck Hauling & Hook Up Equipment	Medical, Fire/Explosion, Spill/Release
Pig Launcher	Medical, Fire/Explosion, Spill/Release

**M & R Station**

<b>Equipment / Materials</b>	<b>Potential Hazard</b>
Flowline	Medical, Fire/Explosion, Spill/Release
Pig Receiver	Medical, Fire/Explosion, Spill/Release
Two Phase Separator	Medical, Fire/Explosion, Spill/Release
Filter Units	Medical, Fire/Explosion, Spill/Release
Heater Unit	Medical, Fire/Explosion, Spill/Release
Dehydration Tower	Medical, Fire/Explosion, Spill/Release
50 – 100 Barrel Water Tank	Medical, Fire/Explosion, Spill/Release
Meter House	Medical, Fire/Explosion, Spill/Release
Meter Skid	Medical, Fire/Explosion, Spill/Release

**B DISTRIBUTION OF THE SITE SAFETY PLAN**

Copies of this Plan will be located at NNE's corporate office building in Charleston, West Virginia, its field office in Morgantown, West Virginia, with the Designated Response Coordinators and field operation sites when applicable. This Plan may be accessed electronically by all NNE employees on the company's shared drive/share point. All NNE employees are to abide by the provisions of this Plan and are required to participate in its implementation. This Plan will also be shared with external entities such as the Monongalia County Office of Emergency Management within at least seven (7) days prior to earth disturbance and/or well work.

Efforts will be made to familiarize police, fire departments, emergency response teams and the County Emergency Management Coordinator with the layout of the well site, the properties and dangers associated with the equipment and materials that are on site, places where personnel would normally be working, and the possible evacuation routes should an emergency occur.

# 4

## **Chemical Inventory & Material Safety Data Sheets ("MSDS")**

**A Material Safety Data Sheets (“MSDS”)**

MSDS Sheets will be provided upon request on a CD or USB drive.

**B Location of MSDS**

MSDS sheets will be kept in the company trailer during the drilling and completion phases of operation. Any Contractors that bring hazardous materials on site will provide MSDS for such. The onsite supervisor will be responsible for ensuring that all MSDS sheets are obtained and are easily accessible in case of an emergency.

**C DRILLING MUD**

1,500 bbl of 12.9 ppg synthetic drilling mud will be used along with the below listed chemicals. The mud will be kept in an open top above ground mud pit and circulated by nozzles and paddles.

Material	Unit	Amount
Barite	4000lb	9
Calcium Chloride Powder	50lb	200
Carbo Gel	50lb	60
Base Oil	1 gal	1440
Lime	50lb	69
Mil Sorb	50lb	87



# 5

# Blow Out Preventer ("BOP") and Well Control

## **A BOP EQUIPMENT – DRILLING PHASE**

From the shoe of the intermediate casing string (9-5/8") to KOP, the well will continue to be drilled on air. For this section, at a minimum, an 11" 3,000 PSI annular-type BOP will be utilized as a means of well control. Installation of this equipment will be dependent upon two different conditions...

- Should the top-hole drilling rig have a substructure large enough to sit upon a cellar, an 11" 5,000 PSI API flanged casing head will be welded onto the top of the intermediate casing string (9-5/8") below grade after it has been set and cement has cured for a minimum of 8 hours. It is upon this casing head that the annular-type BOP will be bolted and torqued to specification as a means of well control for the section.
- Should the top-hole drilling rig have a substructure too small to sit upon a cellar, the intermediate casing string (9-5/8") will be landed at surface and a screw-on or weld flange annular-type BOP will be used as a means of well control for the section. Under this scenario, a cellar will be installed around the wellbore after the top-hole rig is released from the pad. Once installed, an 11" 5,000 PSI API flanged casing head will then be welded onto the top of the intermediate casing string (9-5/8") below grade.

For the remainder of the drilling of the well on fluid; at a minimum and from bottom to top; an 11" 5,000 PSI kill spool, an 11" 5,000 PSI blind ram-type BOP, an 11" 5,000 PSI pipe ram-type BOP, and an 11" 5,000 PSI annular-type BOP will be bolted and torqued to specification upon the 11" 5,000 PSI casing head.

## **B PROCEDURE AND SCHEDULE FOR TESTING BOP**

For the bottom and horizontal wellbore drilling phase, function testing of BOP equipment shall occur upon initial installation, weekly, and after each trip. Pressure testing of all BOP equipment shall occur upon initial installation and every twenty-one (21) days thereafter, should the well not be completed within that time. Annular preventers are to be tested to seventy percent (70%) of the rated capacity and ram preventers should be tested to eighty percent (80%) of the rated capacity according to the following procedure;

- The WV DEP Regional Oil and Gas Inspector will be notified 24 hrs. in advance of the pressure testing of all BOP equipment.
- For the testing of the 3,000 PSI annular-type BOP before drilling through the shoe of the intermediate casing string to KOP, a cup-type tester will be lowered into the intermediate casing (9-5/8") or a plug-type tester will be inserted into the

casing head if installed. After a successful function test, the annular BOP will be closed around drill pipe and the void between the cup or plug will be pressurized using fluid as a medium. This shall consist of a minimum five minute low pressure (300 PSI maximum) test, and a thirty minute high pressure (2,100 PSI minimum) test. Annular preventer and valves shall be tested from the direction they are exposed to wellbore pressure. A successful test shall consist of less than a 10% bleed off after buildup over the entire duration of the low/high test period.

- For the testing of the BOP stack from KOP to TD of the well, a plug-type tester will be placed into the bowl of the 11" 5M x 9-5/8" casing head. After a successful functional test, all rams, valves, TIW valves, chokes, and annular preventers will be pressure tested from the direction they are subjected to wellbore pressure. The annular preventer will be tested by pressurization around drill pipe using water as a medium and subject to a minimum five minute low pressure (300 PSI maximum) test, and a minimum thirty minute high pressure (2,100 PSI minimum for 3M equipment, 3,500 PSI minimum for 5M equipment) test. Rams, valves, TIW, and choke components shall be tested using water as a medium and subject to a minimum five minute low pressure (300 PSI maximum) test, and a minimum thirty minute high pressure (2,400 PSI minimum for 3M equipment, 4,000 PSI minimum for 5M equipment ) test. Each individual component must pass its respective test before drilling may commence. A successful test shall consist of less than a 10% bleed off after buildup over the entire duration of the low/high test period.

## **C ASSEMBLY INSTALLATION SCHEDULE**

- During top hole operations a 11" 5,000 PSI API flanged casing head will be welded onto the top of the intermediate casing string (9-5/8") below grade and an 11" 3,000 PSI annular-type BOP will be used to KOP
- From curve to TD the following will be added to the flanged casing; 11" 5,000 PSI kill spool, 11" 5,000 PSI blind ram-type BOP, 11" 5,000 PSI pipe ram-type BOP, and 11" 5,000 PSI annular-type BOP 11" 5,000 PSI casing head.

**D PERSONNEL WITH WELL CONTROL TRAINING**

Throughout operations, the following Northeast Natural Energy representatives shall have and maintain IADC well control certification:

- Jay Hewitt – Drilling Manager
- Criss VanGilder – Completions Manager
- Any onsite consultant hired to oversee drilling or completions operations

**E SYSTEM OF MAINTAINING DETAILED RECORDS**

A detailed Driller's Log shall be maintained, including but not limited to, lost circulation, the presence of hydrogen sulfide gas, fluid entry, kicks, and abnormal pressures.

**F NOTIFICATION OF THE OFFICE OF OIL AND GAS**

The WV DEP Office of Oil and Gas will be immediately notified of the presence of hydrogen sulfide gas above 10 ppm, significant kicks, or blow-out events.

## G WELL HEAD ASSEMBLY

A 5,000 PSI production tree will be placed upon the tubing spool after the drill out process. This unit will consist of, at a minimum and from bottom to top; one flanged 2-1/16" 5,000 PSI gated master valve, a studed three-way tee, a flanged 2-1/16" 5,000 PSI gated swab valve, and a 5,000 PSI flanged tree cap. The side outlet of the studed three-way tee shall include a flanged 2-1/16" 5,000 PSI gated wing valve. A schematic of the proposed wellhead and tree assembly is attached for reference.

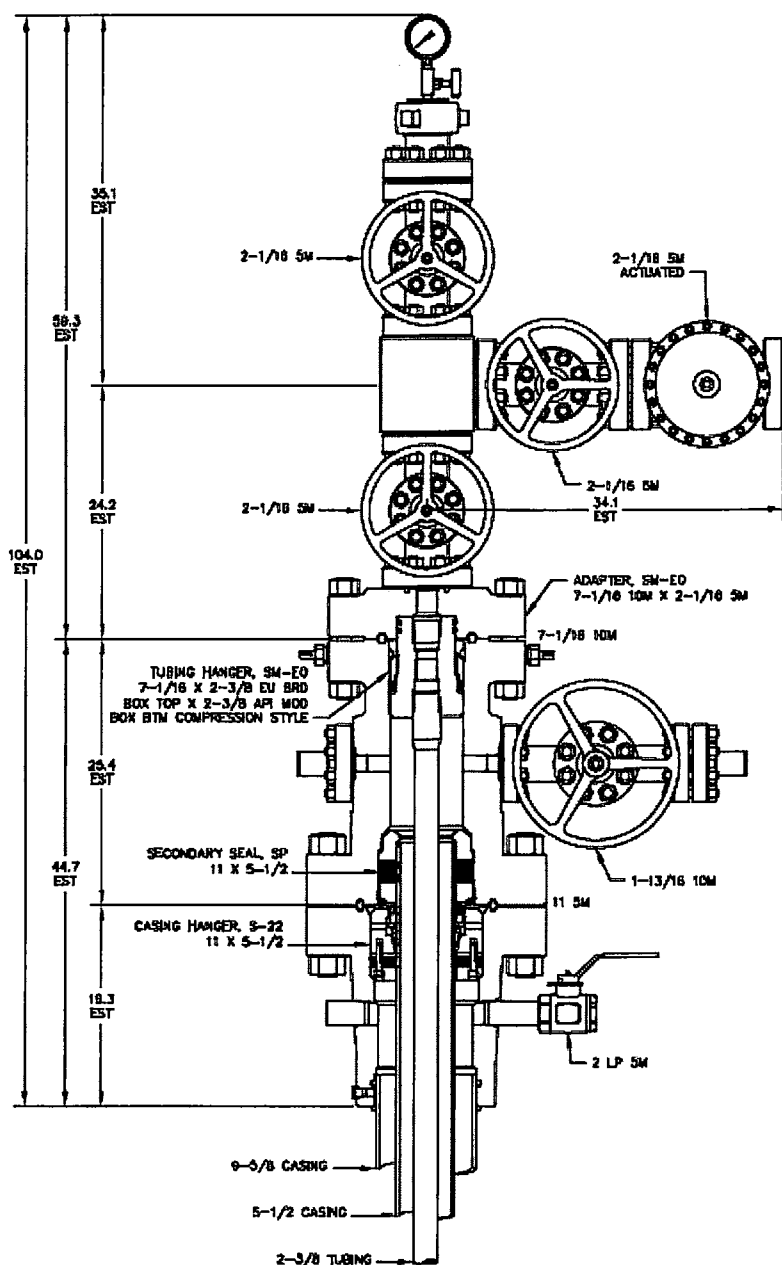

## **H WELL KILLING PROCEDURE**

An oil-based synthetic drilling fluid will be utilized for the bottom and horizontal sections of the well. A total onsite volume of 1,600 Bbls (1.5 times the hole volume) will be maintained at 12.5 ppg. Enough weighting material, in the form of barite, will be kept onsite to increase the density of the entire volume of drilling mud by 1.0 ppg. This constitutes enough weighting material to initiate a 16 ppg slug, should a kick be encountered.

Dual-purpose paddle style mixing/reserve tanks will be used for the blending of mud additives and weighting material. A minimum of two units will be employed, with the final number based upon the drilling contractor selected.

The well will be drilled in an overbalanced manner to maintain control over formation fluids. Should a kick be detected, the well will be killed by either the IADC approved "Driller's Method" or "Wait and Weight" method. Bottomhole pressure will be calculated from SIDPP obtained post-kick, and the drilling fluid density will be increased by adding barite to the system and circulated throughout the wellbore when using the "Wait and Weight" method. After circulation with either method, the well will then be checked for flow, and if none is detected, then drilling operations will resume.

**6**

**Hydrogen  
Sulfide  
("H<sub>2</sub>S")**

**A DETECTION, MONITORING AND WARNING EQUIPMENT**

Based upon previous experience and history in the area, no H<sub>2</sub>S is expected to be encountered during the drilling or completion activities of the Boggess 1H. As a means of additional protection, mud loggers will be utilized during the drilling process to monitor any gas stream from the well through the flowline during the bottom and horizontal sections. Additional portable detection equipment shall be available on or near potential sources of explosive or hydrogen sulfide gases on the pad throughout all operations. Monitoring equipment shall be calibrated by and in accordance with the supplying contractor's guidelines. Detection of either shall sound an alarm which notifies personnel to shut in the well(s) and evacuate to the predetermined safe zone immediately.

**B H<sub>2</sub>S TRAINING**

A safe zone upwind and away from the well will be established at the beginning of each tour. Personnel are trained to evacuate the well and gather at this safe zone immediately at the first sound of an H<sub>2</sub>S explosive gas alarm.

When in a historically known area, or after H<sub>2</sub>S is first detected, operations will halt, evacuation procedures will be followed, and all personnel will be trained for detailed H<sub>2</sub>S protocols before operations begin or resume.

**C NOTIFYING THE OFFICE OF OIL AND GAS**

In the event that H<sub>2</sub>S is encountered, after all personnel have gathered in the safe zone, the onsite supervisor will take a head count, and then proper offsite notifications shall be made. The DEP Office of Oil and Gas will be notified by a phone call to both the local inspector and the emergency number.

**D PROTECTION ZONES**

A wind sock and/or flags will be utilized on location to identify wind direction, and safe zone upwind and away from the well will be established at the beginning of each tour. Personnel are trained to evacuate the well and gather at this safe zone immediately at the first sound of an H<sub>2</sub>S explosive gas alarm.



**E LIST OF PERSONAL PROTECTIVE EQUIPMENT (“PPE”)**

Since drilling in a historically known area to not contain H<sub>2</sub>S through the intervals drilled, H<sub>2</sub>S specific PPE will not be kept on site. Centralized H<sub>2</sub>S alarms, and supplemental personal alarms, will be maintained and used throughout the drilling and completion process. Personnel on site will be notified to cease the current operation safely, shut-in all wells on the pad, and evacuate all personnel to the pre-determined safe zone at the first signal of H<sub>2</sub>S from these alarms. It is at this time that NNE personnel would assess the hazards, and bring in H<sub>2</sub>S specialists and PPE to mitigate the situation. Normal work would return to the pad after all personnel passed a specific H<sub>2</sub>S training and were equipped with the proper PPE.

**7**

# **Flaring**

**A FLARING PLAN**

Post frac, a system of 2" and 3" Figure 1502 integrated-hammer pup joints will be assembled from the wellhead to a 5,000 PSI plug catcher and choke manifold. The choke manifold shall consist of two parallel adjustable chokes to control the initial flow of the well. Using the same construction iron, from the choke manifold, flow will enter a high capacity temporary production unit. The liquid fraction from the well will be diverted to gas buster equipped frac- tanks on location. All or part of the gas fraction from the well will be diverted to a thirty foot flare stack approximately 150' downwind of the wellhead. Any gas not diverted to a flare line shall be diverted to sales.

Iron pipe used in the flow/flare line assembly shall be banded at the joints with chain or steel cable. The flow/flare assembly shall be anchored in place by attachment to concrete blocks at vendor recommended intervals.

The flare stack will be equipped with an electronic ignition system, and a minimum of two backup ignition sticks will be kept on location at all times.

All gas diverted through the choke manifold shall either be burned through the flare stack or sent to sales. The local fire department will be given prior notice of the window in which gas flaring is to occur. They will also be notified immediately prior to lighting the flare, if possible, otherwise, as soon after lighting the flare as possible.

A 50' circumference shall be maintained around the flare stack which is to be kept free of flammable materials at all times prior to and during the flaring of any gas.

It is expected to flare the gas fraction of the well stream for a one week period.

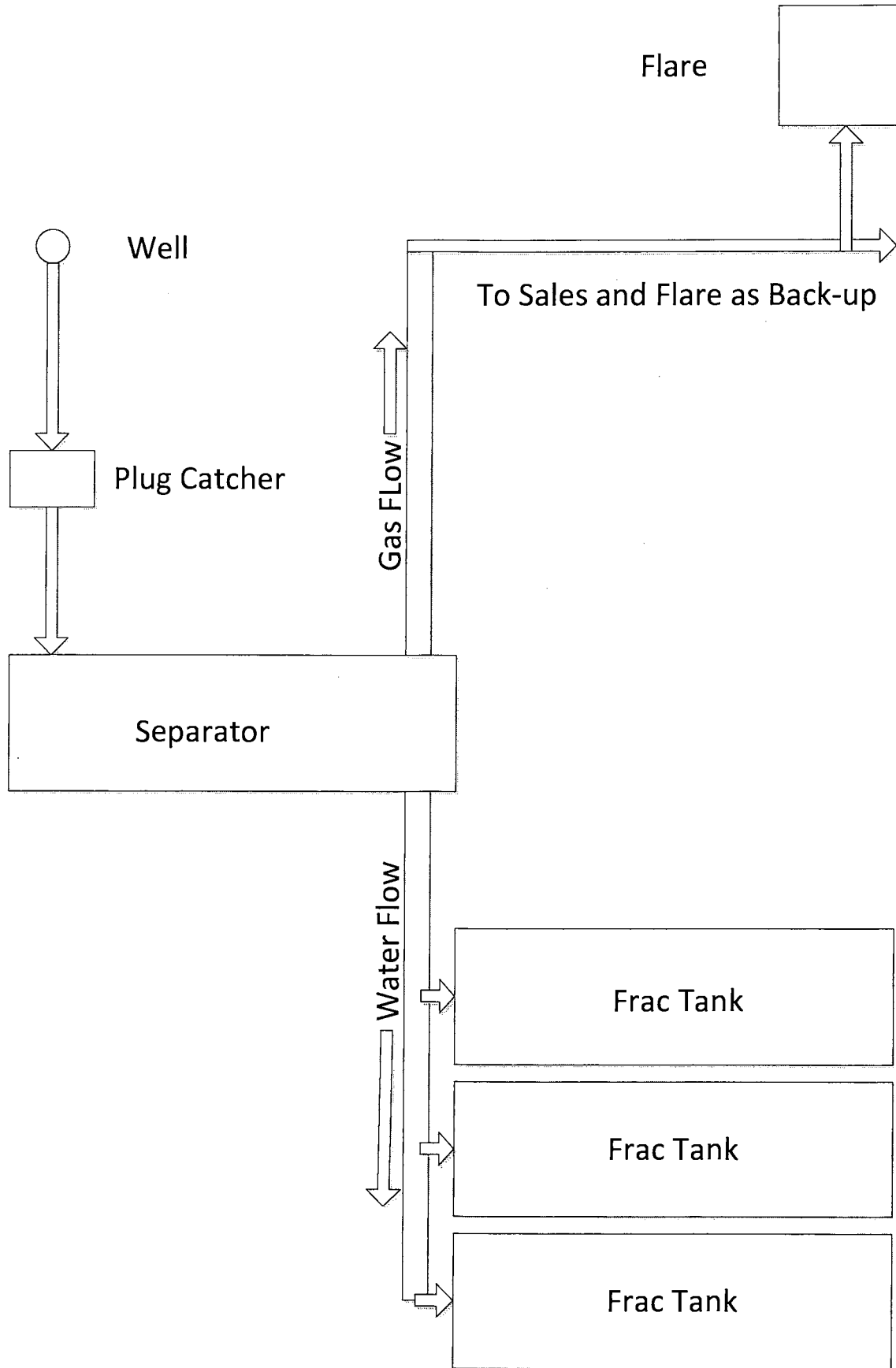

# 8

# **Collision Avoidance Safeguards, Practices and Standards**

**Scope of Work:**

To ensure that wells are drilled in a safe manner that mitigates the risk of underground collisions on multi-well pads. Key portions of work will be described including roles, responsibilities and steps taken when returning to pads with existing producing or stimulated wells.

**Definitions:**

- 1) Proposed Wellbore- Involves sections of the vertical top-hole, the KOP, the lateral landing, and the lateral drilling to the total measured depth (TMD).
- 2) Nudge- Technique generally used in the vertical top-hole section. The well path is nudged from vertical to pass areas of possible magnetic interferences and to reduce the risk of collision by maintaining separation with other wellbores.
- 3) KOP- Kick off Point. Diverting a well path from one trajectory to another
- 4) MWD- Measurement While Drilling
- 5) LWD- Logging While Drilling
- 6) EM - Electromagnetic Telemetry
- 7) SF- Separation Factor or Clearance Factor:  

$$SF^* = CC \div [UR_{ref} + UR_{off}]$$

CC - Well separation distance (center to center of wellbores)  
 $UR_{ref}$  – radius ellipse of uncertainty on reference well  
 $UR_{off}$  – radius ellipse of uncertainty on offset well  
 Note: ellipses are half-axes or radii.

 \*Calculation options may be considered
- 8) TMD- Total Measured Depth
- 9) Gyro – High accuracy well bore survey instrument unaffected by magnetic interference.
- 10) QC / QA – Quality Control and Quality Assurance
- 11) HSE – Health Safety and the Environment
- 12) UBHO Sub – Universal Bottom Hole Orientation Sub

**Established descriptions of risk:**

- |                      |         |                          |
|----------------------|---------|--------------------------|
| 1) $SF \leq 1.0$     | Level 1 | Extreme collision risk   |
| 2) $SF = 1.0$ to 1.5 | Level 2 | High collision risk      |
| 3) $SF = 1.5$ to 2.0 | Level 3 | Moderate collision risk  |
| 4) $SF > 2.0$        | Level 4 | Low to no collision risk |

**Well Planning:**

Prior to drilling any well, a directional plan will be developed to ensure that the well is properly placed with consideration to permits, lease limitations and future drilling plans. The well will be planned to maintain a SF of  $\geq 2.0$  whenever possible. If a SF of  $<2.0$  is encountered, additional risk mitigation steps may be required such as increased survey frequency, wellbore steering or installing downhole mechanical barriers.

**Survey Protocol:**

*When drilling wells on a pad without producing or stimulated wells, surveys will be taken every 30' - 500' in the vertical portion of the wellbore depending on wellbore trajectory, hole walk and risk of collision.*

*When drilling wells on a pad with producing or stimulated wells, surveys will be taken every 30' - 250' in the vertical portion of the wellbore depending on wellbore trajectory, hole walk and risk of collision.*

**Tool Alignment Procedure:**

Tool alignment is critical in eliminating wellbore collision risks. In all wells, north seeking gyro tools, MWD/EM tools and anti-collision processes are utilized to mitigate the risk of downhole collisions. All work groups responsible for the placement of the wellbore share responsibility in ensuring accuracy. The Company Representative, Directional Drilling Supervisor and Gyro Supervisor are all responsible for the alignment of the UBHO Sub and the motor to ensure that azimuthal directional is correct. All parties should visually verify the orientation of the shoe and agree upon a coordinate system and reference point. When possible, MWD tools will be used to minimize risk of incorrect orientation.

**Directional Planning and Controls – Vertical Wellbore:****Drilling Without Stimulated Wellbores:**

When drilling on pads without producing or stimulated wells, all wells will be planned with a minimum SF  $\geq 1.5$ . Surveys will be taken at intervals of 500' to record the well path as it is drilled, but the frequency can be increased if needed. Drilling parameters should be held constant for the vertical portions of all wells to ensure the natural drilling path is similar for all wells on the pad. If two wells come within 10' of each other or a SF

of  $\leq 1.5$  is reached, each survey is monitored closely and anti-collision is run after each survey until the wells are clear of a collision risk.

Following the drilling of the vertical section of the wellbore, a gyro survey will be taken. Anti-collision software will be used to analyze this data to ensure safe wellbore spacing. Internally, the directional company will utilize their own software to monitor and model wellbores for collision risks; but, as a redundancy, NNE will utilize Hawkeye software to validate their results.

#### *Drilling With Stimulated Wellbores:*

If a rig is returning to a pad with producing or stimulated wellbores, additional steps are required to mitigate risks. Prior to commencing drilling, gyro data from existing wells is analyzed to determine normal hole walk. If a well does not have gyro data, a gyro survey will be run. Once all gyro data is gathered, a preliminary well path is planned to identify collision risks. That plan will be used to identify points of concern where additional risk mitigation steps are needed

NNE may choose to drill wells on a pad with active production; however, additional well path management practices will be employed. During this scenario, if two wells come within 14' or a SF  $\leq 2.0$ , each survey is monitored closely and anti-collision re-run after reach survey until the wells are clear of a potential collision. The Survey frequency can vary from 30'-250' depending on wellbore trajectory, hole walk and risk of collision.

#### *Directional Planning and Controls – Curve and Lateral Wellbore:*

While drilling the curve and lateral portions of the wellbores, MWD technology will be used to ensure the well path is drilled according to the drilling plan and the state permit. Azimuth, gamma ray and other data will be collected and transmitted to surface. The information will be analyzed by the Directional Drilling Contractor, Company Representative, Drilling Manager and Geologist to ensure the quality of the data and proper interpretation.

Gyro data and/or MWD/EM data will be evaluated in anti-collision software to monitor the path of the well being drilled in relationship to all adjacent wells to ensure an adequate SF is maintained during the vertical, curve and horizontal portions of the wellbore. Survey frequency is to be a minimum of 100' while MWD/EM tools are being utilized. Each survey is analyzed and certified as accurate by the directional company before it can be used for any modeling or directional planning.



**Other Data:**

Prior to drilling new wells on a pad, a site overview with the wellhead arrangement will be developed. Among the information that will be included is API number, surface footage separation and wellbore status. Additionally, all survey data for each existing well will be compiled for use in well planning.

**Contingency Plans:**

The wellbore being drilled will be monitored in relation to existing wellbores. Should the active well approach an existing well and the SF be  $< 1.5$ , drilling will be suspended until risks are mitigated by adjusting the directional plan, increasing survey frequency and verifying any necessary mechanical barriers are present in the adjacent wells. If a SF  $\leq 1$  is experienced or two wellbores are within 5' of one another, the WV DEP Office of Oil and Gas Regional Inspector will be immediately contacted.

If the wellbore trajectories reach a point where a collision is unavoidable, NNE will properly secure each well and evaluate the most prudent path forward while openly communicating with the WV DEP Oil and Gas Regional Inspector.

Should a collision occur, the WV DEP Office of Oil and Gas Regional Inspector will be immediately contacted, drilling will be suspended and all existing wells will be monitored for integrity. If a loss of pressure control in any well is experienced, Wild Well Control, or another professional well control company, will be contracted for technical support and services. If there is not a loss of pressure control, a separate well work procedure will be developed to repair or plug and abandon the affected wells.



**LEGEND**  
 = PROPOSED WELL

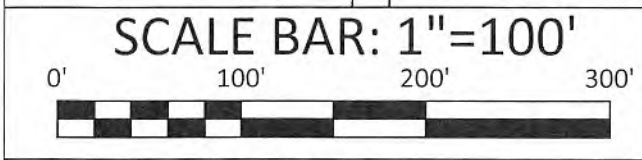

PREPARED FOR  
**NORTHEAST NATURAL ENERGY LLC**  
 BOGCESS WELL PAD  
 CLAY DISTRICT, MONONGALIA COUNTY, WV

PREPARED BY  
**BOORD BENCHEK & ASSOC., INC.**  
 ENGINEERING, SURVEYING, CONSTRUCTION AND  
 MINING SERVICES  
 SOUTHPOINTE, PA 15317 PHONE: 724-746-1055  
 DATE: 1-31-2018

WELL NUMBER	API NUMBER	STATUS
BOGCESS 1H		PROPOSED
BOGCESS 3H		PROPOSED
BOGCESS 5H		PROPOSED
BOGCESS 9H		PROPOSED
BOGCESS 13H		PROPOSED
BOGCESS 17H		PROPOSED



# NORTHEAST NATURAL ENERGY, LLC

Location: Monongalia County, WV      Slot: Slot 01  
Field: Monongalia                      Well: Boggess 1H  
Facility: Boggess Pad                      Wellbore: Boggess 1H PWB



Scale 1 inch = 1000

Easting (ft)

-7500   -6750   -6000   -5250   -4500   -3750   -3000   -2250   -1500   -750   0   750   1500   2250

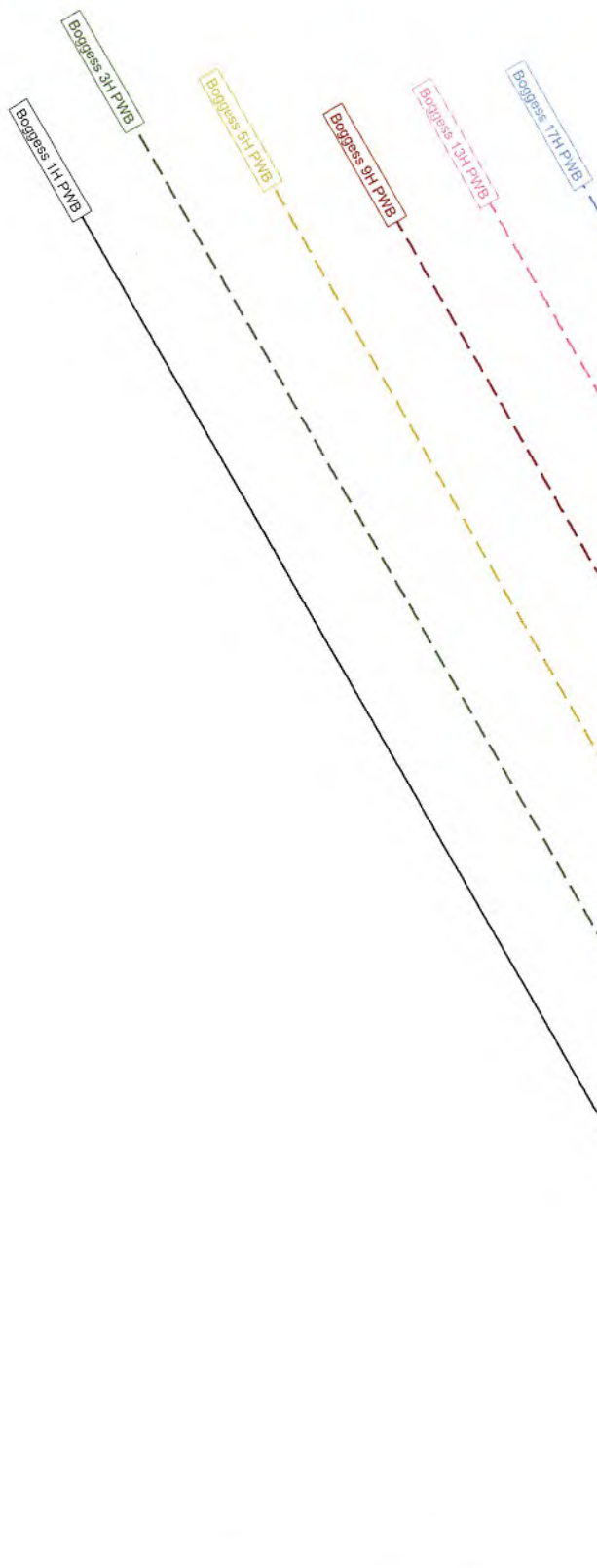

12750  
12000  
11250  
10500  
9750  
9000  
8250  
7500  
6750  
6000  
5250  
4500  
3750  
3000  
2250  
1500  
750  
0

Northing (ft)

12/21/2018



**northeast**  
NATURAL ENERGY

September 27, 2018

WV Department of Environmental Protection  
Office of Oil and Gas  
601 57<sup>th</sup> Street SE  
Charleston, WV 25304

Re: Permit Modification Application

Boggess 1H (47-061-01811), Boggess 3H (47-061-01813), Boggess 5H (47-061-01690), Boggess 9H (47-061-01691),  
Boggess 13H (47-061-01814), Boggess 17H (47-061-01812)

Dear Permit Reviewer,

Northeast Natural Energy LLC ("NNE") received Horizontal 6A permits for wells identified as the Boggess 1H, 3H, 5H, 9H, 13H, and 17H. NNE has since leased additional tracts allowing for the extension of these well bores.

Therefore, please find enclosed permit modification applications to extend the Boggess 1H, 3H, 5H, 9H, 13H, and 17H well bores. Along with the applications are revised Well Bore Schematics, Site Safety Plans, Mylar Plats and Lease Information Forms (WW-6A1).

Should you have any questions please contact me at 304.212.0445 or by email at [kbrooks@nne-llc.com](mailto:kbrooks@nne-llc.com).

RECEIVED  
Office of Oil and Gas

SEP 28 2018

Sincerely,

*Kristen Brooks*

Kristen Brooks  
Regulatory Tech

WV Department of  
Environmental Protection